

## TECHNICAL CATALOGUE

### MONO SPLIT



RAK-18PED  
RAK-25PED/25PEDC  
RAK-35PED/35PEDC  
RAK-50PED/50PEDC  
RAS-X10/14/18EAG  
RAS-L10/14EAG  
RAS-M25/35/50EAG

RAC-18WED  
RAC-25WED  
RAC-35WED  
RAC-X10/14EAG  
RAC-L10/14EAG  
RAC-M25/35EAG



RAC-50WED  
RAC-X18EAG  
RAC-M50EAG



# HITACHI

**Specifications in this catalogue are subject to change without prior notice in order for HITACHI to bring in the latest innovations to their customers**

**Whilst every effort is made to ensure that all dimensions and specifications are correct, any printers' error not rectified are outside the control of HITACHI, who cannot be held responsible for the same**

# CONTENTS

<b>CONTENTS</b>	1
<b>1 SPECIFICATIONS</b>	2
<b>2 DIMENSIONAL DATA</b>	4
<b>3 CAPACITIES TABLE</b>	7
3.1. CAPACITY CHARACTERISTIC CURVES	7
3.2. CORRECTION FACTORS ACCORDING TO PIPING LENGTH	10
3.3. CORRECTION FACTORS ACCORDING TO DEFROSTING OPERATION	12
<b>4 SOUND DATA</b>	13
<b>5 WORKING RANGE</b>	17
5.1. POWER SUPPLY	17
5.2. WORKING RANGE	17
<b>6 ELECTRICAL DATA</b>	18
6.1. INDOOR UNIT	18
6.2. OUTDOOR UNIT	18
<b>7 WIRING DIAGRAM</b>	19
<b>8 REFRIGERANT CYCLE</b>	21
<b>9 CONTROL AND FUNCTION</b>	22
9.1. RAR-5F1	22
9.2. SHIFT VALUE	23
9.3. SETTING THE PREVENTION OF MUTUAL INTERFERENCE	24
9.4. ADDITIONAL FUNCTION VIA DIP-SWITCH SETTINGS	25
9.4.1. AUTO RESTART FUNCTION	25
9.4.2. HEATING/COOLING ONLY MODE SELECTION	25
<b>10 OPTION LIST</b>	26
10.1 WIRED REMOTE CONTROL	26
10.1.1 SHIFT VALUE	26
10.1.2 ERROR CODE INFORMATION	27
10.2 H-LINK ADAPTOR	29
10.2.1 SAFETY SUMMARY	29
10.2.2 INSTALLATION WORK	29
10.2.3 ELECTRICAL WIRING	30
10.2.4 DIP SWITCH SETTING	31
10.2.5 TEST RUN	32
10.3 DRY CONTACT APPLICATION (USING DIP SWITCH)	33

# 1 SPECIFICATIONS

## 1.1. WALL TYPE

INDOOR	Unit	RAK-18PED	RAK-25PED RAK-25PEDC RAS-X10EAG RAS-L10EAG RAS-M25EAG	RAK-35PED RAK-35PEDC RAS-X14EAG RAS-L14EAG RAS-M35EAG	RAK-50PED RAK-50PEDC RAS-X18EAG RAS-M50EAG
Nominal capacity adjustable		no	no	no	no
Nominal Cooling capacity (min - max)	kW	2.00 (0.90 - 2.50)	2.50 (0.90 - 3.10)	3.50 (0.90 - 4.00)	5.00 (1.90- 5.20)
Cooling sensible capacity	kW	1.99	2.28	2.87	3.47
Nominal Heating capacity (min - max)	kW	2.50 (0.90 - 3.20)	3.40 (0.90 - 4.40)	4.20 (0.90 - 5.00)	6.00 (2.20 - 7.30)
Noise level cooling (sound pressure) (SL / L / M / H)	dB(A)	21 / 24 / 33 / 37	22 / 24 / 33 / 40	25 / 26 / 36 / 43	28 / 30 / 40 / 46
Noise level heating (sound pressure) (SL / L / M / H)	dB(A)	19 / 22 / 33 / 38	20 / 23 / 34 / 41	26 / 27 / 36 / 44	25 / 30 / 39 / 47
Noise level (sound power)	dB(A)	51	54	57	60
Air flow cooling mode (SL / L / M / H)	m <sup>3</sup> /h	312/350/400/440	333/370/430/510	333/400/485/600	333/450/600/700
Air flow heating mode (SL / L / M / H)	m <sup>3</sup> /h	312/350/420/480	333/400/500/570	333/520/550/660	433/510/650/770
Fan Motor	W	30	30	30	30
Dehumidification	l/h	1.2	1.4	1.6	2.0
Dimensions (H x W x D)	mm	280 x 780 x 215	280 x 780 x 215	280 x 780 x 215	280 x 780 x 215
Weight	kg	7.5	7.5	7.5	8
Colour		Star White (N9.3)	Star White (N9.3)	Star White (N9.3)	Star White (N9.3)
Condensate Drain	mm	φ16mm	φ16mm	φ16mm	φ16mm
Running current (C/H)	A	1.09-4.39/1.09-4.22	1.09-5.61/1.09-5.43	1.09-6.35/1.09-7.39	2.17-9.13/2.17-11.96
Power supply		220-230V	220-230V	220-230V	220-230V
Cable section (Interconnection)	mm <sup>2</sup>	1.50x 3+EARTH/-	1.50x 3+EARTH/-	1.50x 3+EARTH/-	2.50x 3+EARTH/-
Piping diameter (Liq / Gas)	Inch	1/4" / 3/8"	1/4" / 3/8"	1/4" / 3/8"	1/4" / 1/2"
Drain diameter (ext)	mm	φ16mm	φ16mm	φ16mm	φ16mm
Remote control (standard/optional) *		RAR-5F1/SPX-RCDB	RAR-5F1/SPX-RCDB	RAR-5F1/SPX-RCDB	RAR-5F1/SPX-RCDB
<b>Filter</b>					
ACL Filter		Activated carbon (optional)	Activated carbon (optional)	Activated carbon (optional)	Activated carbon (optional)
ACL part name		SPX-CFH25	SPX-CFH25	SPX-CFH25	SPX-CFH25
Pre-filter (Standard/Optional)		Washable/ SPX-SPF8	Washable/ SPX-SPF8	Washable/ SPX-SPF8	Washable/ SPX-SPF8

### NOTE:

1. The nominal cooling and heating capacity is the combined capacity of the HITACHI standard split system, and are based on the ISO 5151.

Operation Conditions		Cooling	Heating
Indoor Air Inlet Temperature	dB	27.0 °C	20.0 °C
	WB	19.0 °C	15.0 °C
Outdoor Air Inlet Temperature	dB	35.0 °C	7.0 °C
	WB	24.0 °C	6.0 °C
Piping Length: 5.0 meters; Piping Lift: 0 meter dB: Dry Bulb; WB: Wet Bulb			

2. The Sound Pressure Level is based on the following conditions:

- 0.8 meter beneath indoor height center
- 1 meter from Discharge grille

The above data was measured in an anechoic chamber. Please take into consideration reflected sound of your specific site

## 1.2. WALL TYPE

OUTDOOR	UNIT	RAC-18WED	RAC-25WED RAC-X10EAG RAC-L10EAG RAC-M25EAG	RAC-35WED RAC-X14EAG RAC-L14EAG RAC-M35EAG	RAC-50WED RAC-X18EAG RAC-M50EAG	
Nominal Cooling capacity (min - max)	kW	2.00 (0.90 - 2.50)	2.50 (0.90 - 3.10)	3.50 (0.90 - 4.00)	5.00 (1.90 - 5.20)	
Nominal Heating capacity (min - max)	kW	2.50 (0.90 - 3.20)	3.40 (0.90 - 4.40)	4.20 (0.90 - 5.00)	6.00 (2.20 - 7.30)	
Nominal cooling power input (min - max)	kW	0.58(0.25 - 1.01)	0.70 (0.25 - 1.29)	1.09 (0.25 - 1.46)	1.56 (0.50 - 2.10)	
Nominal heating power input (min - max)	kW	0.62(0.25 - 0.97)	0.88 (0.25 - 1.25)	1.10 (0.25 - 1.70)	1.66 (0.50 - 2.75)	
EER / COP		3.45/4.03	3.57/3.86	3.21/3.82	3.21/3.61	
SEER / SCOP		6.10/4.20	6.10/4.20	6.10/4.20	6.10/4.30	
Energy class (SEER/SCOP)		A++/A+	A++/A+	A++/A+	A++/A+	
Noise level cooling (sound pressure)	dB(A)	45	47	48	50	
Noise level heating (sound pressure)	dB(A)	46	48	49	50	
Noise level (sound power)	dB(A)	59	61	62	64	
Air flow (Cooling / Heating)	m <sup>3</sup> /h	1860 / 1620	1860 / 1620	1860 / 1620	2160 / 2160	
Dimensions (H x W x D)	mm	530x660 x278	530x660 x278	530x660 x278	600x792x299	
Weight	kg	23	23	24.5	39.5	
Colour		Beige (5Y7/2)	Beige (5Y7/2)	Beige (5Y7/2)	Beige (5Y7/2)	
Power supply		230V/1Ph/50Hz	230V/1Ph/50Hz	230V/1Ph/50Hz	230V/1Ph/50Hz	
Recommended fuse size	A	15	15	15	25	
Starting current (C/H)	A	3.19/3.62	3.84/4.56	5.41/5.56	7.16/7.62	
Running current (C/H)	A	1.09-4.39/1.09-4.22	1.09-5.61/1.09-5.43	1.09-6.35/1.09-7.39	2.17-9.13/2.17-11.96	
Cable section (Power)	mm <sup>2</sup>	1.50x 2+EARTH	1.50x 2+EARTH	1.50x 2+EARTH	2.50x 2+EARTH	
Cable section (Interconnection)	mm <sup>2</sup>	1.50x 3+EARTH	1.50x 3+EARTH	1.50x 3+EARTH	2.50x 3+EARTH	
Piping diameter (Liq / Gas)		1/4" / 3/8"	1/4" / 3/8"	1/4" / 3/8"	1/4" / 1/2"	
Minimum piping length	m	3	3	3	3	
Maximum piping length / height difference	m	20 / 10	20 / 10	20 / 10	20 / 10	
Current quantity of refrigerant / Chargeless	kg	0.53	0.53	0.70	0.93	
Chargeless / Additional refrigerant charge	m / g/m	20/-	20/-	20/-	20/-	
Working range (cooling / heating)	°C	-10°C-43°C/ -15°C-21°C	-10°C-43°C/ -15°C-21°C	-10°C-43°C/ -15°C-21°C	-10°C-43°C/ -15°C-21°C	
Refrigerant		R32	R32	R32	R32	
Condenser Fan		Propeller Fan	Propeller Fan	Propeller Fan	Propeller Fan	
Compressor	Type		ROTARY	ROTARY	ROTARY	2 Cylinder Rotary
	Oil Charge	mL	320±20	320±20	320±20	480±20
	Oil Type		ACS-68R or equivalent	ACS-68R or equivalent	ACS-68R or equivalent	ACS-68R or equivalent
	Coil Resistance	Ω	2.167 at 20°C	2.167 at 20°C	2.167 at 20°C	1.354 at 20°C
	Quantity		1	1	1	1

### NOTE:

1. The Sound Pressure Level is based on the following conditions:

- 1 meter from the unit front surface and 1 meter from floor level

The above data was measured in an anechoic chamber. Please take into consideration reflected sound of your specific site

## 2 DIMENSIONAL DATA

2.1. WALL TYPE: RAK-18PED, RAK-25PED, RAK-35PED, RAK-50PED  
 RAK-25PEDC, RAK-35PEDC, RAK-50PEDC  
 RAS-X10EAG, RAS-X14EAG, RAS-X18EAG  
 RAS-L10EAG, RAS-L14EAG  
 RAS-M25EAG, RAS-M35EAG, RAS-M50EAG

Unit : mm

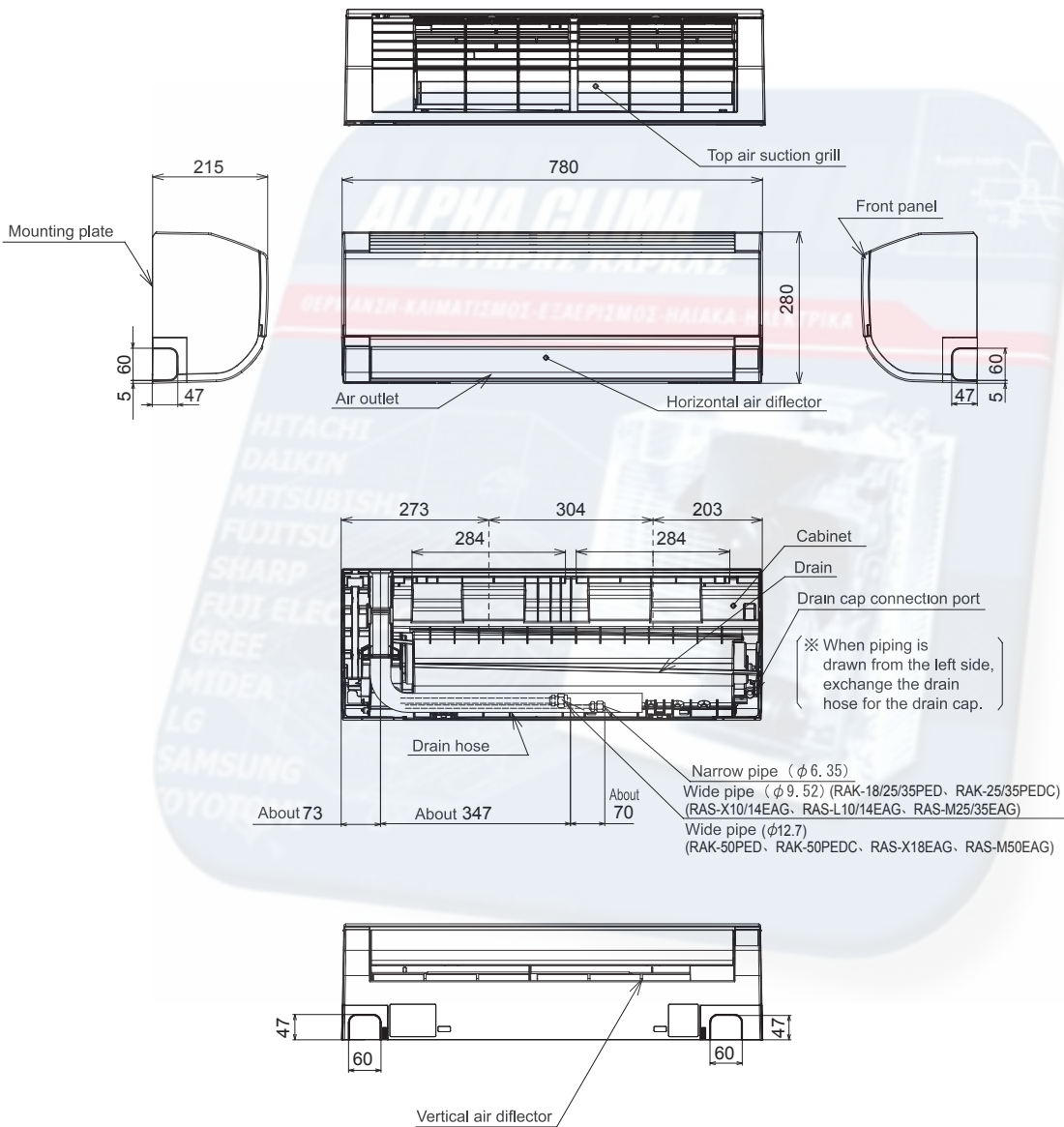

**2.2. WALL TYPE: RAC-18WED,RAC-25WED,RAC-35WED  
RAC-X10EAG,RAC-X14EAG  
RAC-L10EAG,RAC-L14EAG  
RAC-M25EAG,RAC-M35EAG**

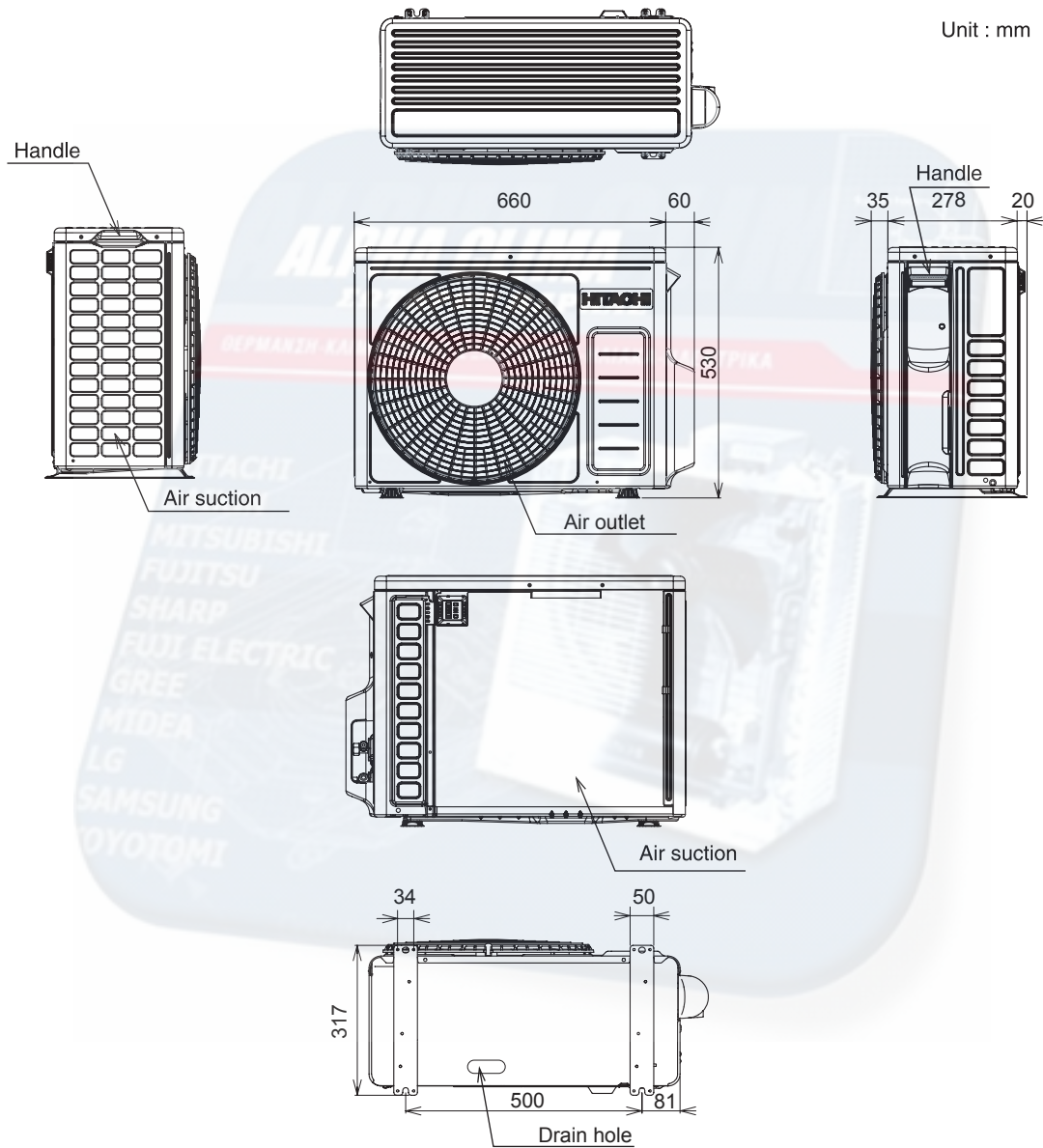

2.3. WALL TYPE: RAC-50WED,RAC-X18EAG,RAC-M50EAG

Unit : mm

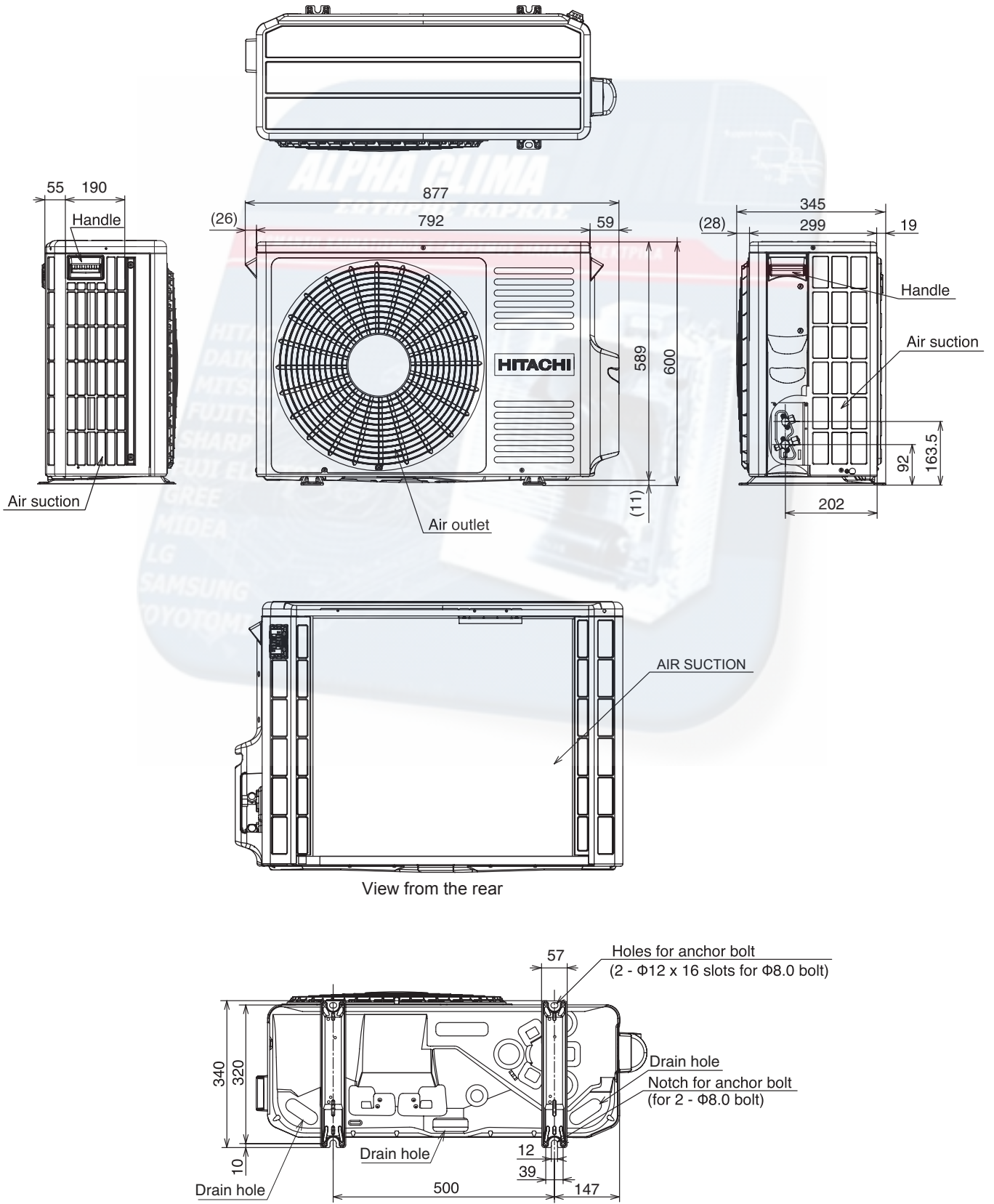



## 3 CAPACITIES TABLE

### 3.1. CAPACITY CHARACTERISTIC CURVES

The following charts show the characteristics of outdoor unit capacity, which corresponds with the operating ambient temperature of outdoor unit.

Conditions:

① Pipe length / height difference : 5m / 0m

③ Compressor at rated inverter frequency

② Indoor fan speed at High mode

④ Capacity loss due to white frost and defrost operation is not included.

#### 3.1.1. RAK-18PED/RAC-18WED

### COOLING [50Hz, 230V]

INDOOR		OUTDOOR TEMPERATURE (° CDB)																				
° C	° C	-10			21			27			32			35			40			43		
		TC	SHC	PI	TC	SHC	PI	TC	SHC	PI	TC	SHC	PI	TC	SHC	PI	TC	SHC	PI	TC	SHC	PI
12.0	18	1556	1455	324	1763	1940	384	1631	1791	453	1640	1811	534	1580	1731	557	1480	1632	597	1420	1552	621
14.0	20	1556	1455	324	1894	1940	384	1763	1810	458	1760	1811	539	1700	1751	563	1580	1632	603	1520	1572	632
16.0	22	1556	1548	329	2025	1940	389	1875	1810	464	1880	1811	545	1820	1751	574	1700	1632	615	1640	1572	638
18.0	25	1669	1660	334	2156	2108	394	1988	1959	469	2000	1970	551	1920	1891	574	1800	1771	621	1720	1692	644
19.0	27	1725	1716	339	2231	2220	399	2063	2052	474	2080	2070	557	2000	1990	580	1880	1871	621	1800	1791	644
22.0	30	1913	1698	339	2475	2201	399	2288	2034	474	2300	2050	563	2220	1970	586	2000	1910	644	1860	1871	679
24.0	32	2044	1698	344	2644	2201	405	2438	2034	480	2460	2050	563	2360	1970	592	2080	1950	661	1900	1930	702

### HEATING [50Hz, 230V]

INDOOR		OUTDOOR TEMPERATURE (° CDB)																							
° C	° C	-15			-10			-7			-5			0			7			10			15		
		TC	SHC	PI	TC	SHC	PI	TC	SHC	PI	TC	SHC	PI	TC	SHC	PI	TC	SHC	PI	TC	SHC	PI	TC	SHC	PI
16.0	1525	0	642	1838	0	674	2018	0	700	2078	0	696	2235	0	676	2471	0	669	2660	0	690	2954	0	728	
18.0	1538	0	636	1850	0	667	2034	0	690	2096	0	684	2255	0	663	2486	0	644	2674	0	664	2977	0	699	
20.0	1550	0	630	1863	0	661	2050	0	680	2114	0	671	2275	0	650	2500	0	620	2688	0	639	3000	0	670	
22.0	1563	0	624	1875	0	655	2066	0	670	2132	0	659	2295	0	637	2514	0	596	2701	0	613	3023	0	641	
24.0	1575	0	618	1888	0	649	2082	0	660	2151	0	647	2315	0	624	2529	0	571	2715	0	587	3046	0	612	

EWB : Evaporator Wet Bulb temperature (°C)

EDB : Evaporator Dry Bulb temperature (°C)

(°CDB) : Outdoor Unit Inlet Air Dry Bulb Temperature (°C)

TC : Total Capacity (W)

SHC : Sensible Heating Capacity (W)

PI : Power Input

**3.1.2. RAK-25PED/RAC-25WED RAK-25PEDC/RAC-25WED RAS-X10EAG/RAC-X10EAG**  
**RAS-L10EAG/RAC-L10EAG RAS-M25EAG/RAC-M25EAG**

### COOLING [50Hz, 230V]

INDOOR		OUTDOOR TEMPERATURE (° CDB)																				
EWB	EDB	-10			21			27			32			35			40			43		
° C	° C	TC	SHC	PI	TC	SHC	PI	TC	SHC	PI	TC	SHC	PI	TC	SHC	PI	TC	SHC	PI	TC	SHC	PI
12.0	18	1945	1667	391	2203	2223	464	2039	2052	547	2050	2075	644	1975	1984	672	1850	1870	721	1775	1778	749
14.0	20	1945	1667	391	2367	2223	464	2203	2073	553	2200	2075	651	2125	2006	679	1975	1870	728	1900	1801	763
16.0	22	1945	1774	397	2531	2223	470	2344	2073	560	2350	2075	658	2275	2006	693	2125	1870	742	2050	1801	770
18.0	25	2086	1902	403	2695	2415	476	2484	2244	566	2500	2257	665	2400	2166	693	2250	2029	749	2150	1938	777
19.0	27	2156	1967	409	2789	2544	482	2578	2351	572	2600	2371	672	2500	2280	700	2350	2143	749	2250	2052	777
22.0	30	2391	1945	409	3094	2522	482	2859	2330	572	2875	2348	679	2775	2257	707	2500	2189	777	2325	2143	819
24.0	32	2555	1945	415	3305	2522	488	3047	2330	579	3075	2348	679	2950	2257	714	2600	2234	798	2375	2212	847

### HEATING [50Hz, 230V]

INDOOR		OUTDOOR TEMPERATURE (° CDB)																							
EDB		-15			-10			-7			-5			0			7			10			15		
° C	° C	TC	SHC	PI	TC	SHC	PI	TC	SHC	PI	TC	SHC	PI	TC	SHC	PI	TC	SHC	PI	TC	SHC	PI			
16.0	2266	0	1138	2860	0	1188	3207	0	1228	3222	0	1189	3271	0	1077	3361	0	949	3719	0	983	4287	0	1042	
18.0	2283	0	1129	2877	0	1179	3229	0	1214	3247	0	1172	3298	0	1059	3380	0	915	3738	0	947	4319	0	1001	
20.0	2300	0	1120	2894	0	1170	3250	0	1200	3271	0	1154	3325	0	1040	3400	0	880	3756	0	910	4350	0	960	
22.0	2317	0	1111	2911	0	1161	3271	0	1186	3296	0	1137	3352	0	1021	3420	0	845	3775	0	873	4381	0	919	
24.0	2334	0	1102	2928	0	1152	3293	0	1172	3321	0	1120	3379	0	1003	3439	0	811	3794	0	837	4413	0	878	

**3.1.3. RAK-35PED/RAC-35WED RAK-35PEDC/RAC-35WED RAS-X14EAG/RAC-X14EAG**  
**RAS-L14EAG/RAC-L14EAG RAS-M35EAG/RAC-M35EAG**

### COOLING [50Hz, 230V]

INDOOR		OUTDOOR TEMPERATURE (° CDB)																				
EWB	EDB	-10			21			27			32			35			40			43		
° C	° C	TC	SHC	PI	TC	SHC	PI	TC	SHC	PI	TC	SHC	PI	TC	SHC	PI	TC	SHC	PI	TC	SHC	PI
12.0	18	1895	1460	423	2146	1947	502	1986	1797	592	2870	2612	1003	2765	2497	1046	2590	2353	1123	2485	2239	1166
14.0	20	1895	1460	423	2305	1947	502	2146	1816	599	3080	2612	1014	2975	2526	1057	2765	2353	1134	2660	2267	1188
16.0	22	1895	1554	430	2465	1947	509	2283	1816	606	3290	2612	1025	3185	2526	1079	2975	2353	1155	2870	2267	1199
18.0	25	2032	1666	436	2625	2115	516	2420	1965	613	3500	2841	1036	3360	2727	1079	3150	2554	1166	3010	2440	1210
19.0	27	2100	1722	443	2716	2227	522	2511	2059	620	3640	2985	1046	3500	2870	1090	3290	2698	1166	3150	2583	1210
22.0	30	2328	1703	443	3013	2209	522	2785	2040	620	4025	2956	1057	3885	2841	1101	3500	2755	1210	3255	2698	1275
24.0	32	2488	1703	450	3218	2209	529	2967	2040	627	4305	2956	1057	4130	2841	1112	3640	2813	1243	3325	2784	1319

### HEATING [50Hz, 230V]

INDOOR		OUTDOOR TEMPERATURE (° CDB)																							
EDB		-15			-10			-7			-5			0			7			10			15		
° C	° C	TC	SHC	PI	TC	SHC	PI	TC	SHC	PI	TC	SHC	PI	TC	SHC	PI	TC	SHC	PI	TC	SHC	PI			
16.0	2658	0	1152	3314	0	1321	3697	0	1435	3753	0	1401	3908	0	1297	4152	0	1186	4548	0	1293	5172	0	1472	
18.0	2679	0	1141	3335	0	1310	3723	0	1417	3784	0	1379	3941	0	1273	4176	0	1143	4571	0	1247	5211	0	1421	
20.0	2700	0	1130	3356	0	1299	3750	0	1400	3814	0	1357	3975	0	1250	4200	0	1100	4594	0	1201	5250	0	1370	
22.0	2721	0	1119	3377	0	1288	3777	0	1383	3845	0	1335	4009	0	1227	4224	0	1057	4617	0	1156	5289	0	1319	
24.0	2742	0	1108	3398	0	1277	3803	0	1365	3875	0	1314	4042	0	1203	4248	0	1014	4640	0	1110	5328	0	1268	

EWB : Evaporator Wet Bulb temperature (°C)  
 EDB : Evaporator Dry Bulb temperature (°C)  
 (°CDB) : Outdoor Unit Inlet Air Dry Bulb Temperature (°C)

TC : Total Capacity (W)  
 SHC : Sensible Heating Capacity (W)  
 PI : Power Input

**3.1.4. RAK-50PED/RAC-50WED RAS-X18EAG/RAC-X18EAG RAS-M50EAG/RAC-M50EAG  
RAK-50PEDC/RAC-50WED**

**COOLING [50Hz, 230V]**

INDOOR		OUTDOOR TEMPERATURE (° CDB)																				
EWB ° C	EDB ° C	-10			21			27			32			35			40			43		
		TC	SHC	PI	TC	SHC	PI	TC	SHC	PI	TC	SHC	PI	TC	SHC	PI	TC	SHC	PI	TC	SHC	PI
12.0	18	2621	1709	586	3463	2659	812	3205	2455	958	4100	3158	1435	3950	3019	1498	3700	2845	1607	3550	2707	1669
14.0	20	2621	1709	586	3721	2659	812	3463	2480	969	4400	3158	1451	4250	3054	1513	3950	2845	1622	3800	2741	1700
16.0	22	2621	1819	596	3979	2659	823	3684	2480	980	4700	3158	1466	4550	3054	1544	4250	2845	1654	4100	2741	1716
18.0	25	2811	1951	605	4237	2889	834	3905	2685	991	5000	3435	1482	4800	3297	1544	4500	3088	1669	4300	2950	1732
19.0	27	2905	2016	614	4384	3043	845	4053	2813	1003	5200	3609	1498	5000	3470	1560	4700	3262	1669	4500	3123	1732
22.0	30	3221	1994	614	4863	3017	845	4495	2787	1003	5750	3574	1513	5550	3435	1576	5000	3331	1732	4650	3262	1825
24.0	32	3442	1994	623	5195	3017	855	4789	2787	1014	6150	3574	1513	5900	3435	1591	5200	3401	1778	4750	3366	1888

**HEATING [50Hz, 230V]**

INDOOR		OUTDOOR TEMPERATURE (° CDB)																							
EDB ° C	TC	-15			-10			-7			-5			0			7			10			15		
		SHC	PI	TC	SHC	PI	TC	SHC	PI	TC	SHC	PI	TC	SHC	PI	TC	SHC	PI	TC	SHC	PI	TC	SHC	PI	
16.0	3740	0	1883	4615	0	1977	5124	0	2053	5227	0	2017	5504	0	1901	5931	0	1790	6459	0	1854	7289	0	1964	
18.0	3770	0	1867	4645	0	1960	5162	0	2026	5271	0	1984	5552	0	1865	5966	0	1725	6492	0	1785	7345	0	1887	
20.0	3800	0	1850	4675	0	1944	5200	0	2000	5314	0	1951	5600	0	1830	6000	0	1660	6525	0	1716	7400	0	1810	
22.0	3830	0	1833	4705	0	1927	5238	0	1974	5358	0	1919	5648	0	1795	6035	0	1595	6558	0	1647	7456	0	1733	
24.0	3860	0	1817	4735	0	1911	5276	0	1947	5401	0	1886	5696	0	1759	6069	0	1530	6591	0	1578	7511	0	1656	

EWB : Evaporator Wet Bulb temperature (°C)  
EDB : Evaporator Dry Bulb temperature (°C)  
(°CDB) : Outdoor Unit Inlet Air Dry Bulb Temperature (°C)

TC : Total Capacity (W)  
SHC : Sensible Heating Capacity (W)  
PI : Power Input

### 3.2. CORRECTION FACTORS ACCORDING TO PIPING LENGTH

Correction Factor for **Cooling Capacity** according to Piping Length

The cooling capacity should be corrected according to the following formula:

$$CCA = CC \times F$$

- CCA: Actual Corrected Cooling Capacity (kcal/h)
- CC: Cooling Capacity in the Performance Table (kcal/h)
- F: Correction Factor Based on the Equivalent Piping Length

Correction Factor for **Heating Capacity** according to Piping Length

The heating capacity should be corrected according to the following formula:

$$HCA = HC \times F$$

- HCA: Actual Corrected Heating Capacity (kcal/h)
- HC: Heating Capacity in the Performance Table (kcal/h)
- F: Correction Factor Based on the Equivalent Piping Length

The correction factors are shown in the following figure.

Equivalent Piping Length for:

- One 90° Elbow is 0.5m.
- One 180° Curve is 1.5m.

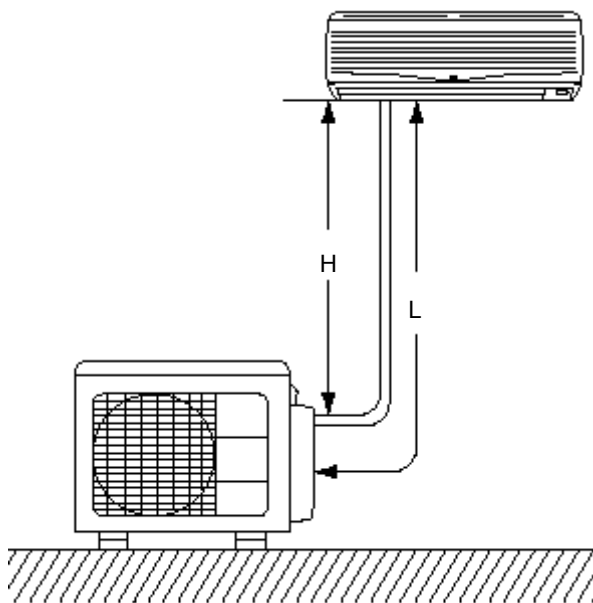

- H: Vertical Distance Between Indoor Unit and Outdoor Units in Meters
- L: Actual One-Way Piping Length Between Indoor Unit and Outdoor Unit in Meters
- EL: Equivalent Total Distance Between Indoor Unit and Outdoor Unit in Meters (Equivalent One-Way Piping Length)

Models : RAK-18PED/RAC-18WED, RAK-25PED/RAC-25WED, RAK-35PED/RAC-35WED  
 RAK-25PEDC/RAC-25WED, RAK-35PEDC/RAC-35WED  
 RAS-X10EAG/RAC-X10EAG, RAS-X14EAG/RAC-X14EAG  
 RAS-L10EAG/RAC-L10EAG, RAS-L14EAG/RAC-L14EAG  
 RAS-M25EAG/RAC-M25EAG, RAS-M35EAG/RAC-M35EAG

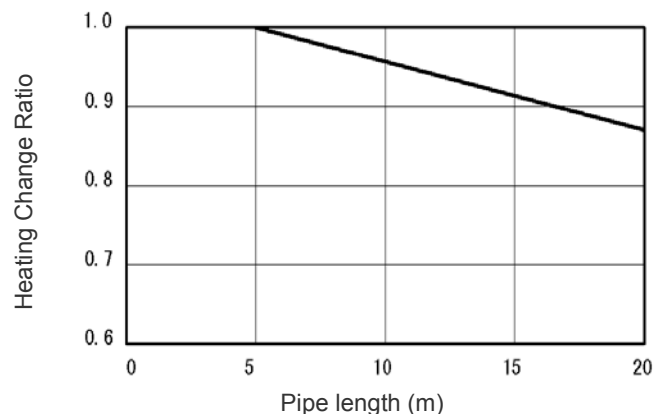
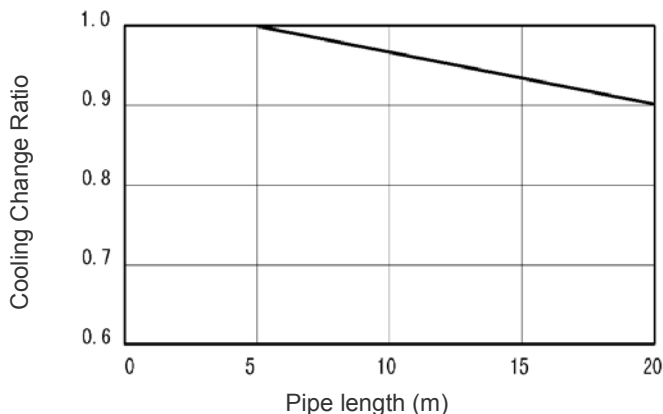

Models : RAK-50PED/RAC-50WED  
RAK-50PEDC/RAC-50WED  
RAS-X18EAG/RAC-X18EAG  
RAS-M50EAG/RAC-M50EAG

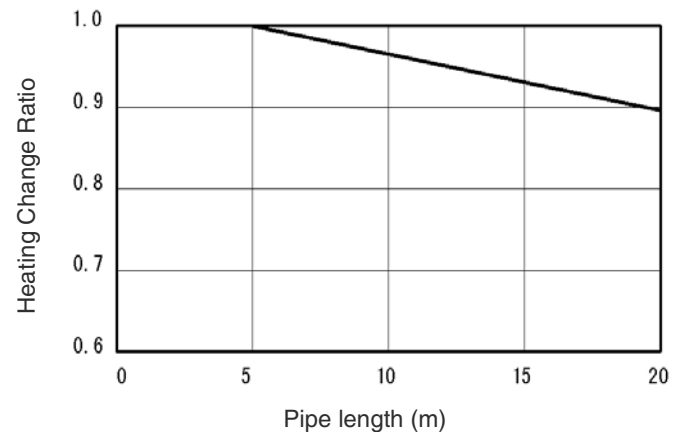
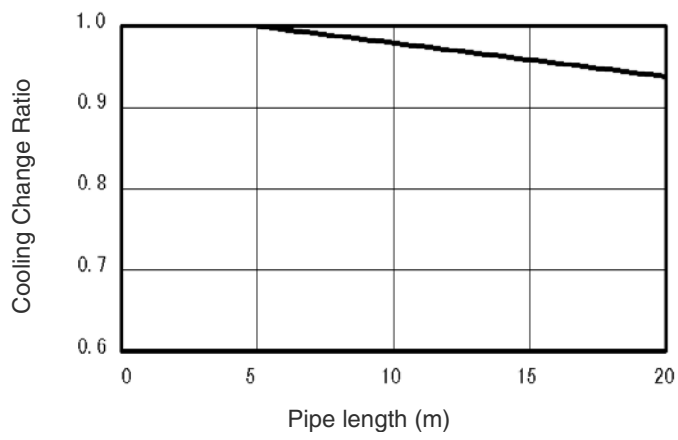

### 3.3. CORRECTION FACTORS ACCORDING TO DEFROSTING OPERATION

The heating capacity in the preceding paragraph, excludes the condition of the frost or the defrosting operation period. In consideration of the frost or the defrosting operation, the heating capacity is corrected by the equation below.

Corrected heating capacity = Defrost Correction factor x unit capacity

OUTDOOR TEMPERATURE (°CDB)	-15	-10	-5	0	7	10	15
Correction factor (humidity rate85% RH)	0.95	0.95	0.91	0.81	1.0	1.0	1.0

Correction Factor

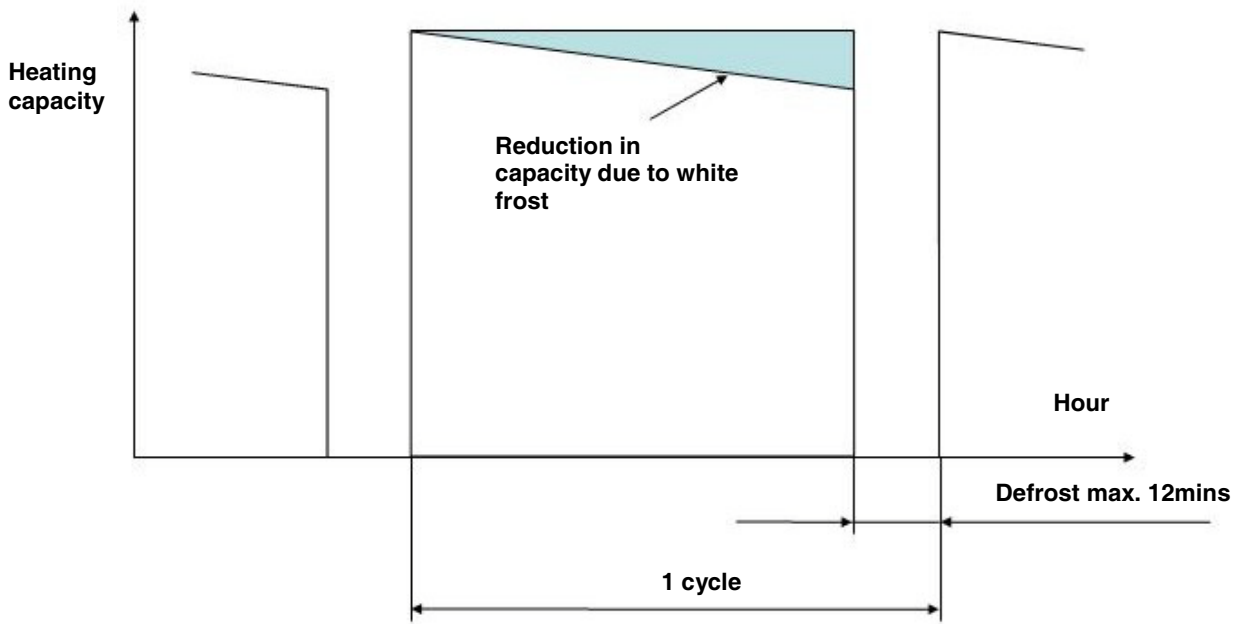

**NOTE:**

The correction factor is not valid for special conditions such as snowfall or operation in a transitional period.

## 4 SOUND DATA

### 4.1. RAC-18WED

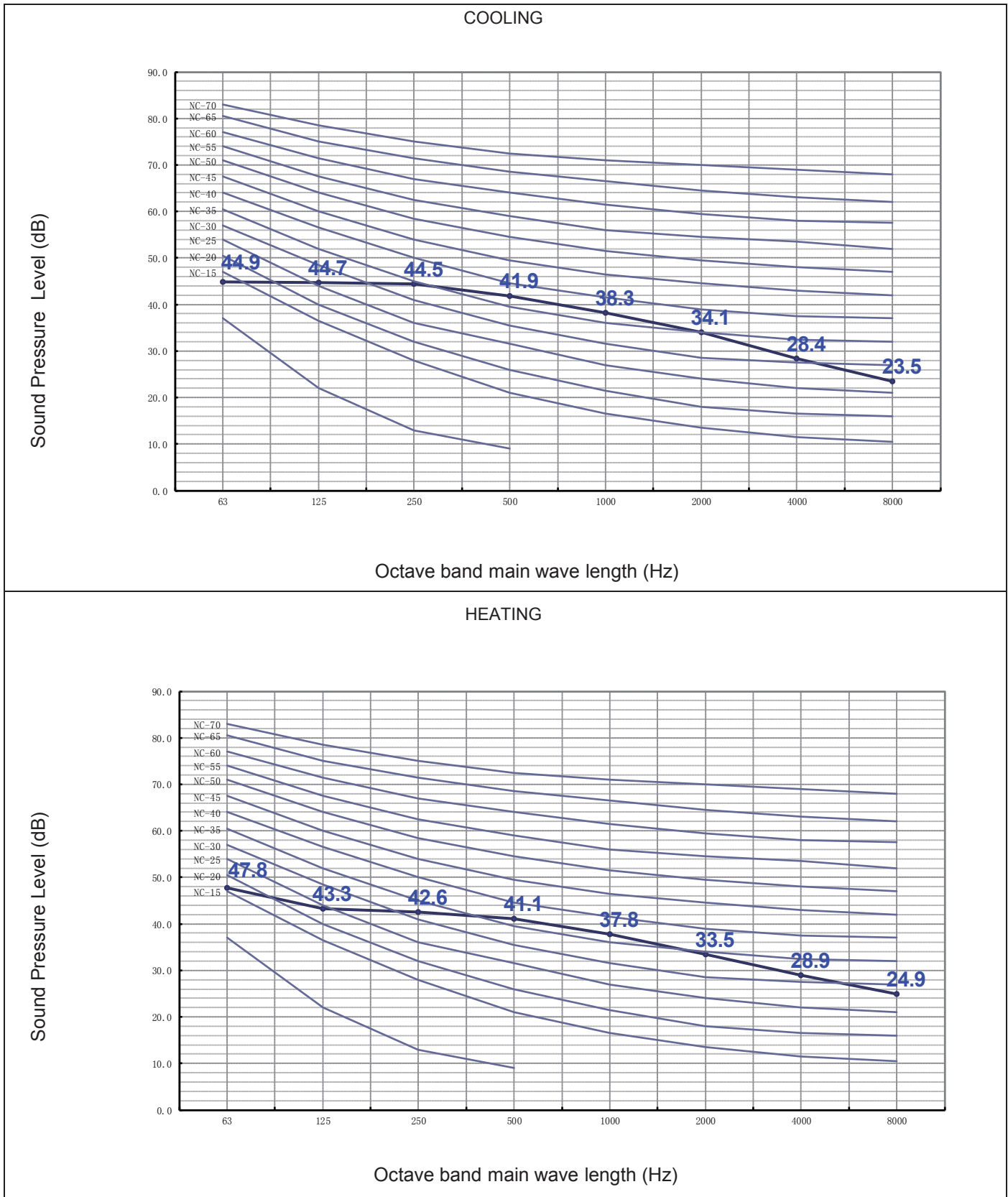

The Sound Pressure Level is based on the following conditions:

1 meter from the unit front surface and 1 meter from floor level

The above data was measured in an anechoic chamber. Please take into consideration reflected sound of your specific site

4.2. RAC-25WED,RAC-L10EAG,RAC-X10EAG,RAC-M25EAG

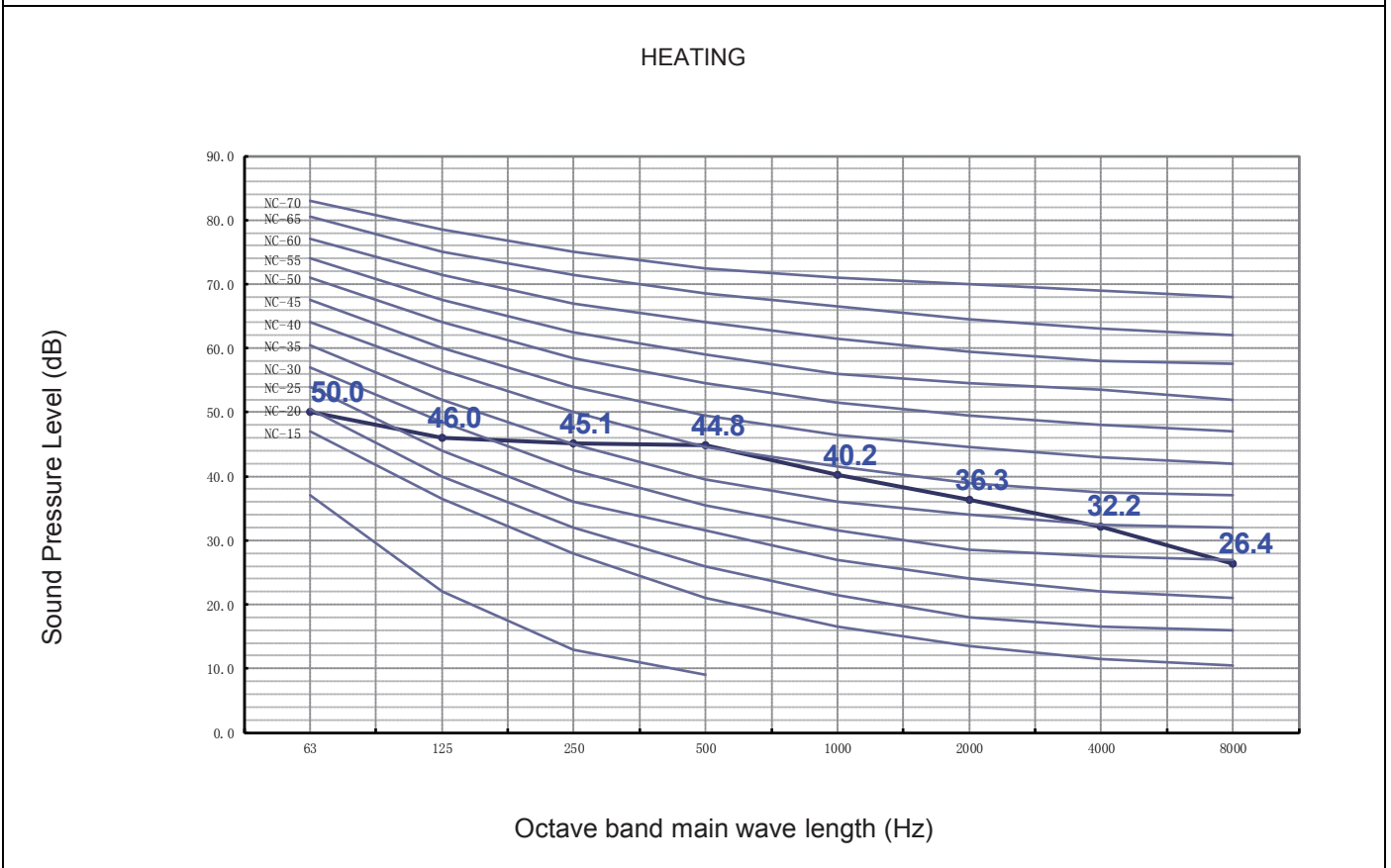
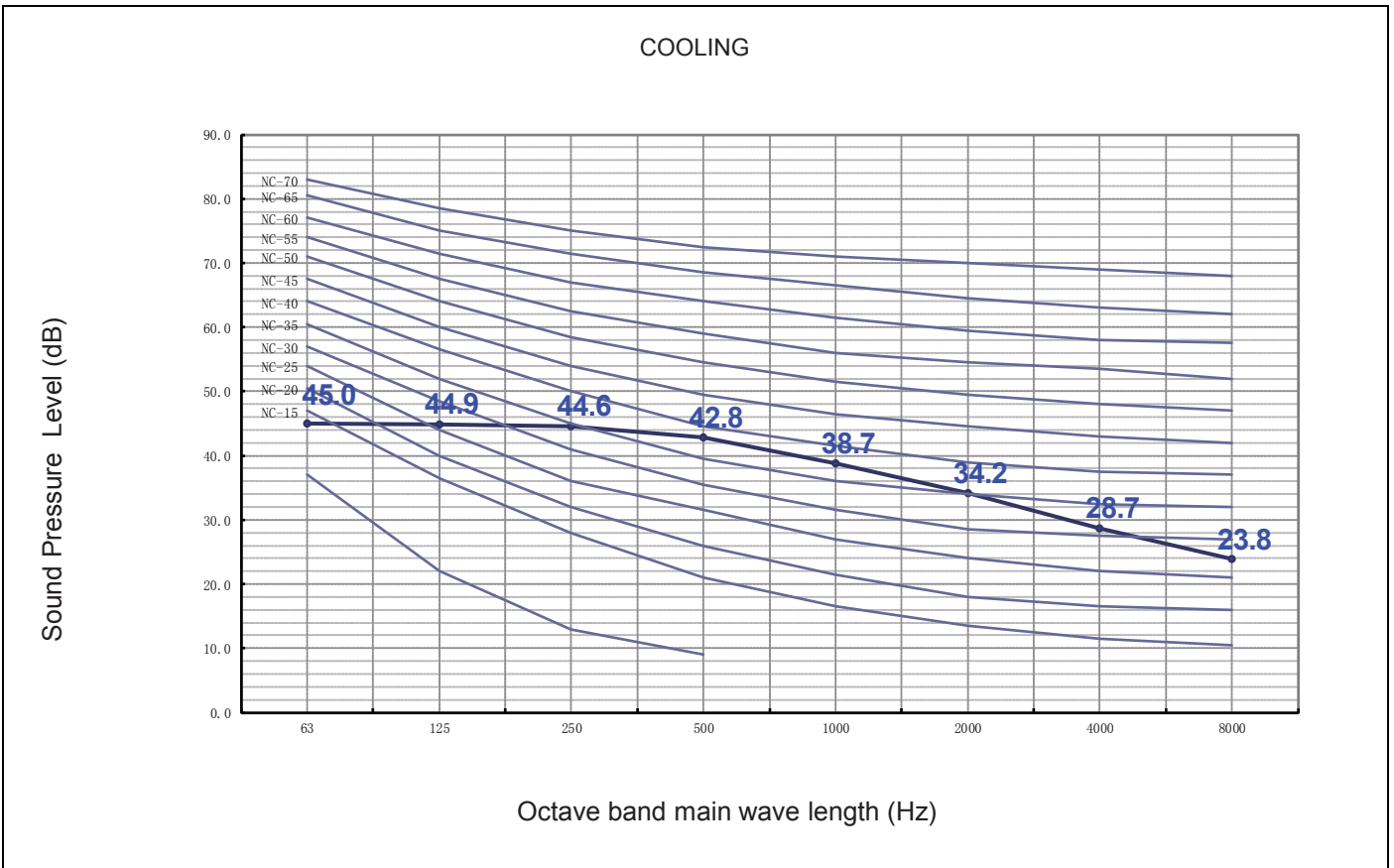

The Sound Pressure Level is based on the following conditions:

1 meter from the unit front surface and 1 meter from floor level

The above data was measured in an anechoic chamber. Please take into consideration reflected sound of your specific site



4.3. RAC-35WED,RAC-L14EAG,RAC-X14EAG,RAC-M35EAG

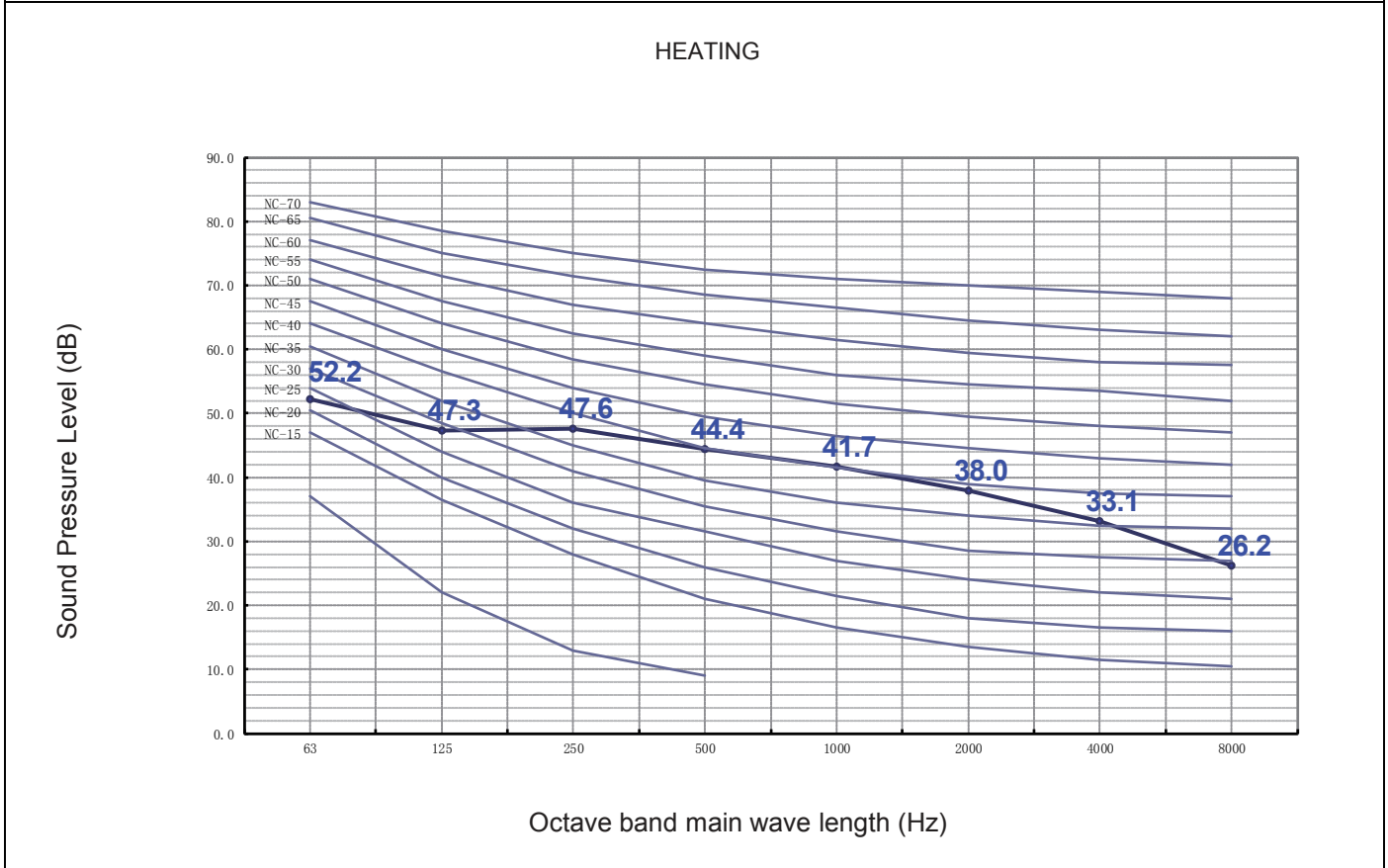
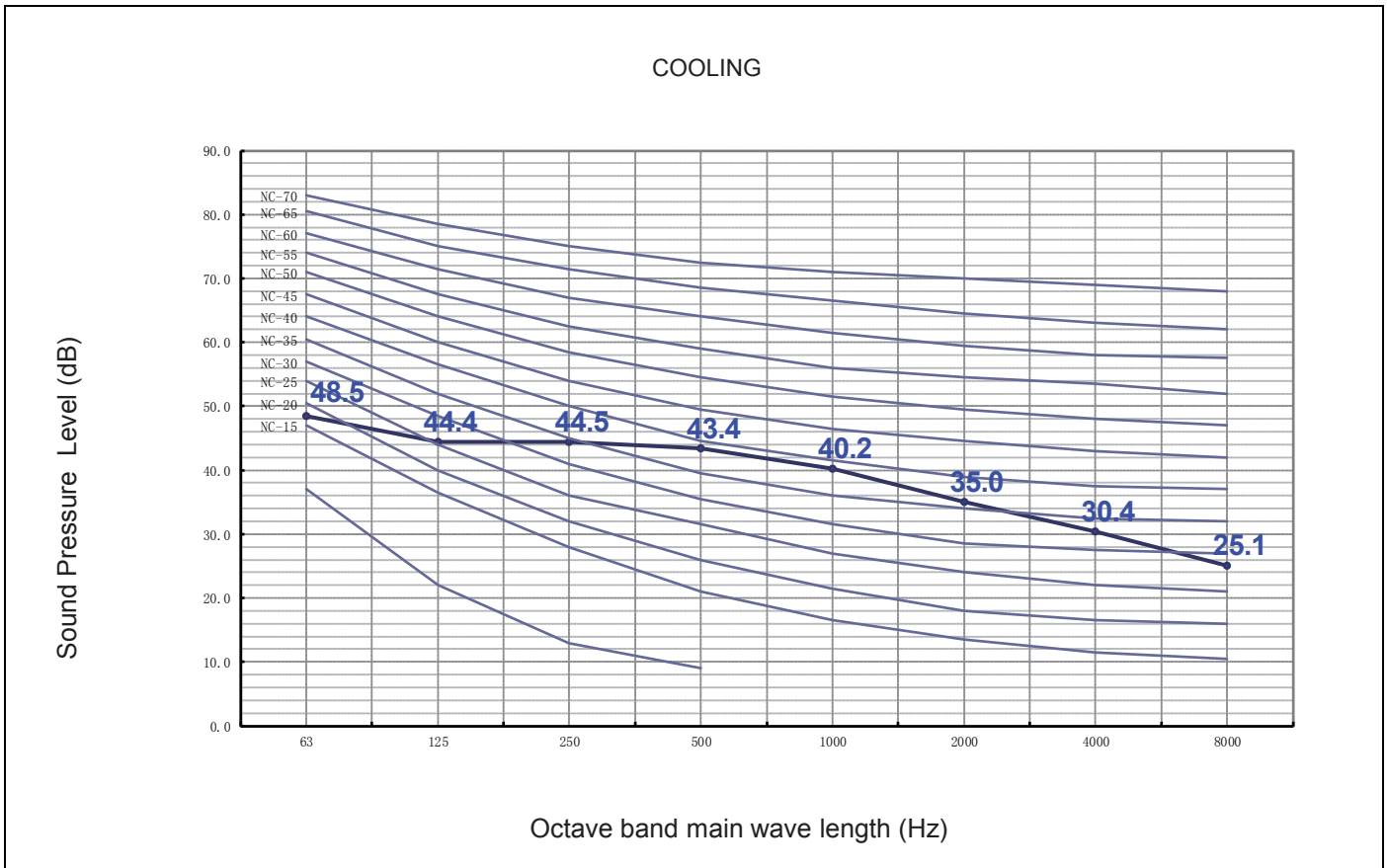

The Sound Pressure Level is based on the following conditions:

1 meter from the unit front surface and 1 meter from floor level

The above data was measured in an anechoic chamber. Please take into consideration reflected sound of your specific site

4.4. RAC-50WED,RAC-X18EAG.RAC-M50EAG

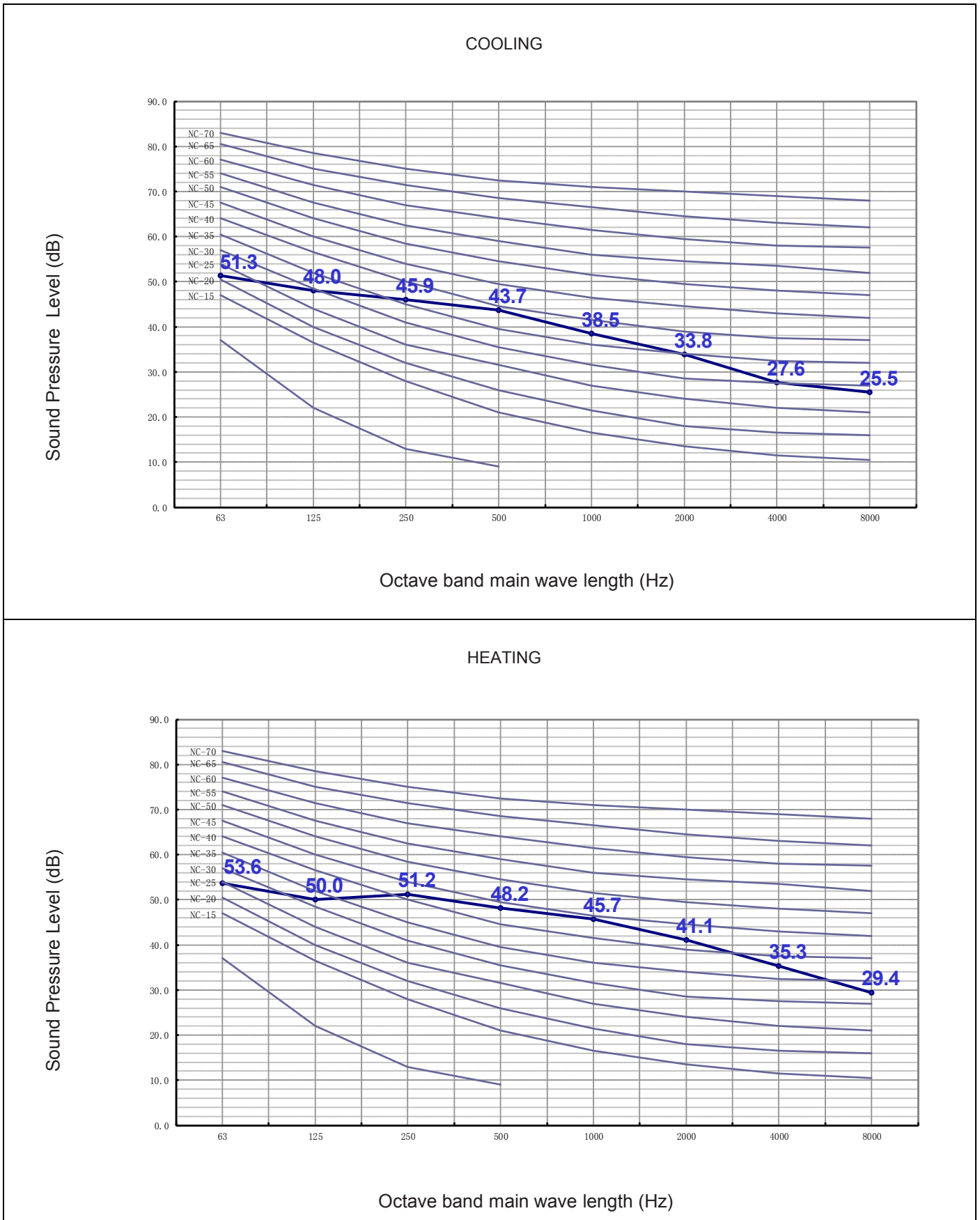

The Sound Pressure Level is based on the following conditions:

1 meter from the unit front surface and 1 meter from floor level

The above data was measured in an anechoic chamber. Please take into consideration reflected sound of your specific site

## 5 WORKING RANGE

### 5.1. POWER SUPPLY

<b>Working Voltage</b>	207V ~ 253V
<b>Voltage Imbalance</b>	Within a 3% Deviation from Each Voltage at the Main Terminal of Outdoor Unit
<b>Starting Voltage</b>	Higher than 85% of the Rated Voltage

### 5.2. WORKING RANGE

Applicable models:

RAC-18WED,RAC-25WED,RAC-35WED,RAC-50WED
RAC-X10EAG,RAC-X14EAG,RAC-X18EAG
RAC-L10EAG,RAC-L14EAG
RAC-M25EAG,RAC-M35EAG,RAC-M50EAG

The temperature range is indicated in the following table.

#### Cooling

working range	min (°C)	max (°C)	rated (°C)
outdoor	-10	43	35
indoor	16	32	27

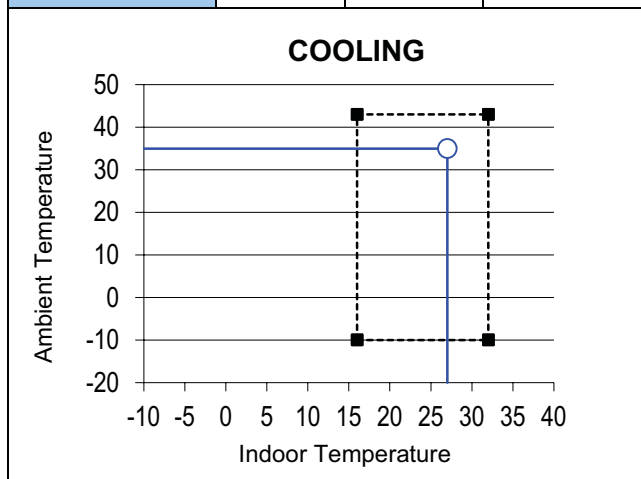

#### Heating

working range	min (°C)	max (°C)	rated (°C)
outdoor	-15	21	7
indoor	16	26	20

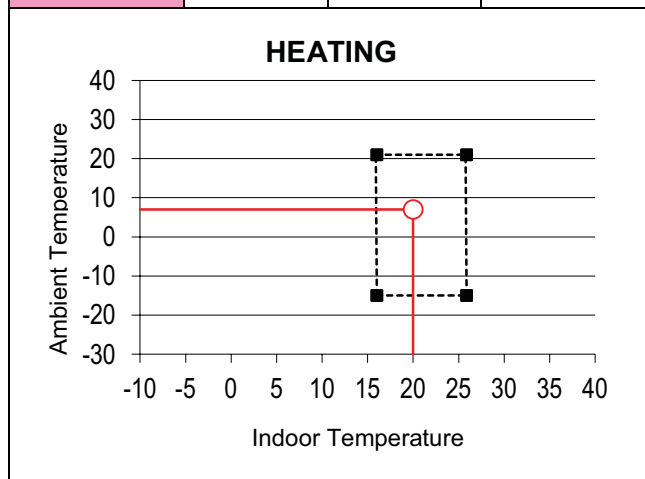

## 6 ELECTRICAL DATA

### 6.1. INDOOR UNIT

Model	Unit Main Power		Applicable Current		Indoor Fan Motor	
	VOL, PH, Hz	Fuse Rating (A)	STC	RNC	RNC	IPT
RAK-18PED	230,1,50	3.15	(C)3.19 (H)3.62	(C) 4.39 (H) 4.22	0.67	30
RAK-25PED RAK-25PEDC RAS-L10EAG RAS-X10EAG RAS-M25EAG	230,1,50	3.15	(C)3.84 (H)4.56	(C) 5.61 (H) 5.43	0.67	30
RAK-35PED RAK-35PEDC RAS-L14EAG RAS-X14EAG RAS-M35EAG	230,1,50	3.15	(C)5.41 (H)5.56	(C) 6.35 (H) 7.39	0.67	30
RAK-50PED RAK-50PEDC RAS-X18EAG RAS-M50EAG	230,1,50	3.15	(C)7.16 (H)7.62	(C) 9.13 (H) 11.96	0.67	30

VOL: Rated Unit Power Supply Voltage (V)  
Hz: Frequency (Hz)  
STC: Starting Current (A)

RNC: Running Current (A)  
PH: Phase ( $\phi$ )  
IPT: Input (W)

### 6.2. OUTDOOR UNIT

Model	Unit Main Power				Compressor Motor					
	VOL, PH, Hz	Fuse Rating (A)	Min (V)	Max (V)	Locked Rotor Ampere (A)	STC	Cooling Operation		Heating Operation	
							RNC	IPT	RNC	IPT
RAC-18WED	220 ~ 230, 1, 50	15	207	253	-	3.62	4.39	580	4.22	620
RAC-25WED RAC-L10EAG RAC-X10EAG RAC-M25EAG	220 ~ 230, 1, 50	15	207	253	-	4.56	5.61	700	5.43	880
RAC-35WED RAC-L14EAG RAC-X14EAG RAC-M35EAG	220 ~ 230, 1, 50	15	207	253	-	5.56	6.35	1090	7.39	1100
RAC-50WED RAC-X18EAG RAC-M50EAG	220 ~ 230, 1, 50	25	207	253	-	7.62	9.13	1560	11.96	1660

VOL: Rated Unit Power Supply Voltage (V)  
HZ: Frequency (Hz)  
STC: Starting Current (A)

RNC: Running Current (A)  
PH: Phase ( $\phi$ )  
IPT: Input (W)

**NOTE:**

1. The above compressor data is based on 100% capacity combination of indoor units at the rated operating frequency
2. This data is based on the same conditions as the nominal heating and cooling capacities.
3. The compressor started by an inverter, resulting in extremely low starting current.

7 WIRING DIAGRAM

7.1. RAK-18PED,RAK-25PED,RAK-35PED,RAK-50PED  
 RAK-25PEDC,RAK-35PEDC,RAK-50PEDC  
 RAS-X10EAG,RAS-X14EAG,RAS-X18EAG  
 RAS-L10EAG,RAS-L14EAG  
 RAS-M25EAG,RAS-M35EAG,RAS-M50EAG

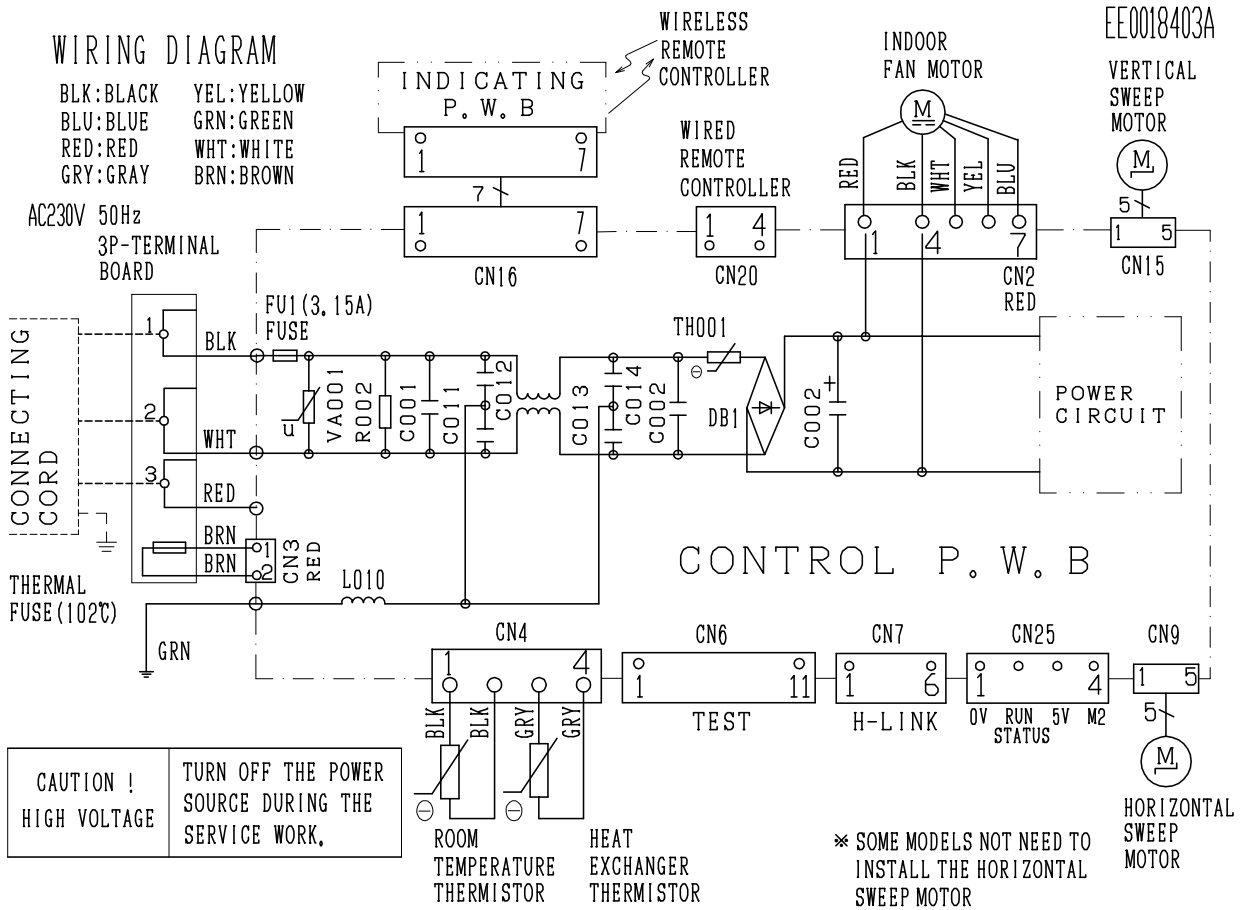

7.2.

**RAC-18WED,RAC-25WED,RAC-35WED  
RAC-X10EAG,RAC-X14EAG  
RAC-L10EAG,RAC-L14EAG  
RAC-M25EAG,RAC-M35EAG**

**RAC-50WED  
RAC-X18EAG  
RAC-M50EAG**

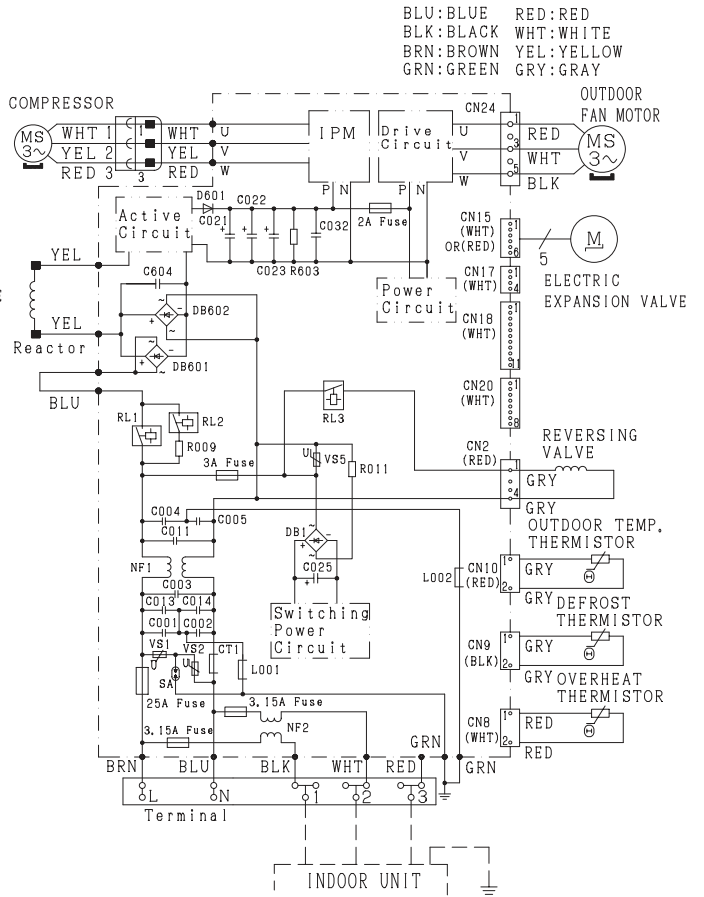
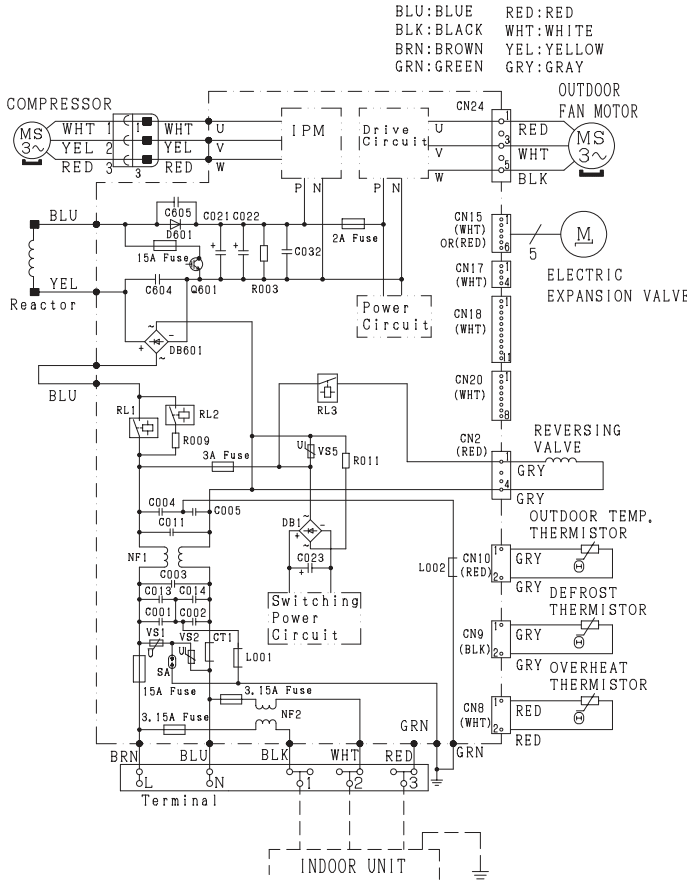

## 8 REFRIGERANT CYCLE

### 8.1. WALL TYPE: RAK-18PED/RAC-18WED, RAK-25PED/RAC-25WED, RAK-25PEDC/RAC-25WED, RAS-L10EAG/RAC-L10EAG, RAS-X10EAG/RAC-X10EAG, RAS-M25EAG/RAC-M25EAG

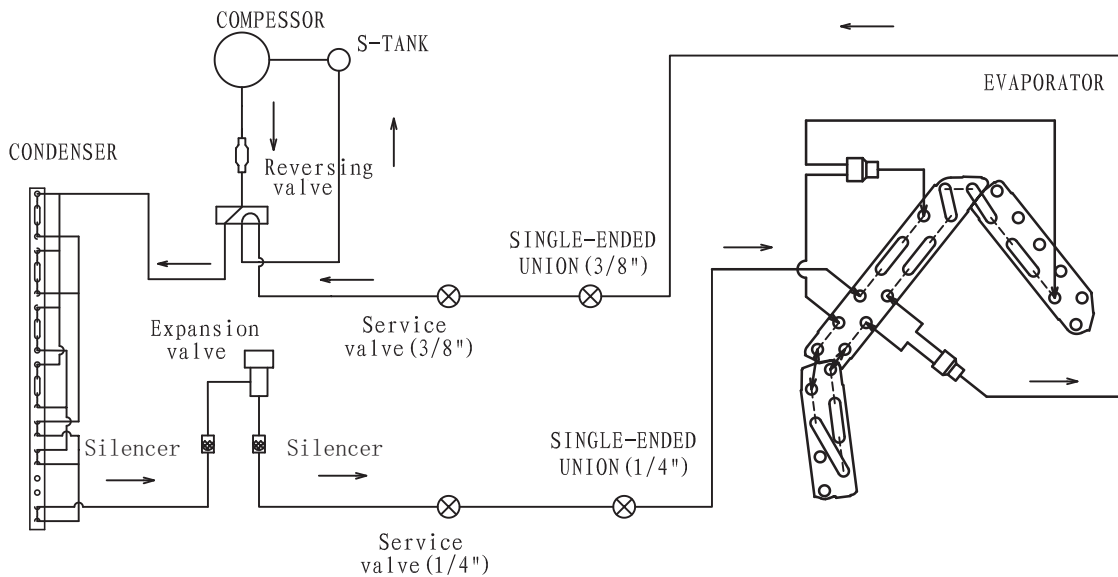

### 8.2. WALL TYPE: RAK-35PED / RAC-35WED, RAK-35PEDC/RAC-35WED, RAS-L14EAG/RAC-L14EAG, RAS-X14EAG/RAC-X14EAG, RAS-M35EAG/RAC-M35EAG

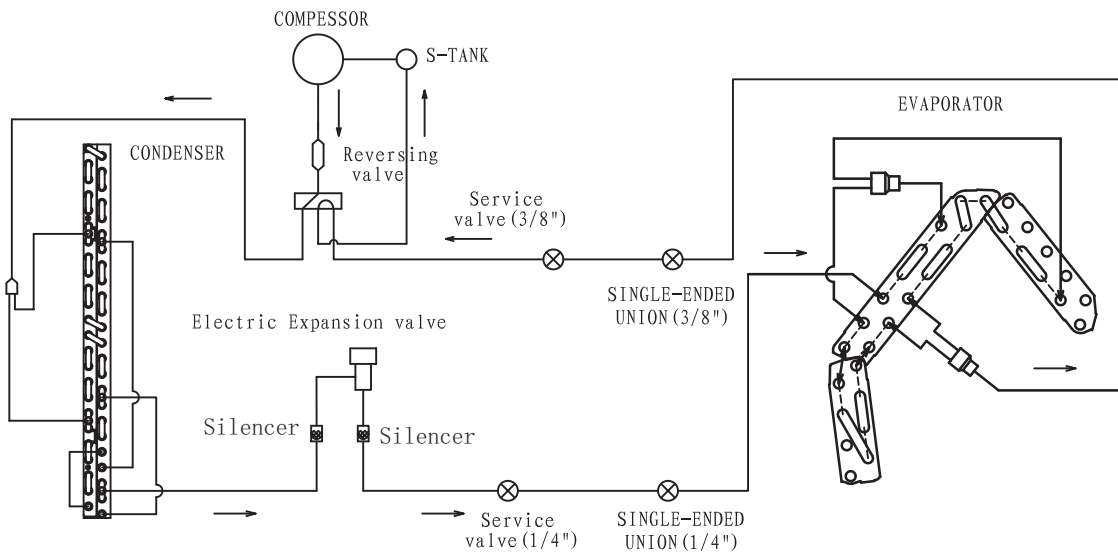

### 8.3. WALL TYPE: RAK-50PED/RAC-50WED, RAK-50PEDC/RAC-50WED, RAS-X18EAG/RAC-X18EAG, RAS-M50EAG/RAC-M50EAG

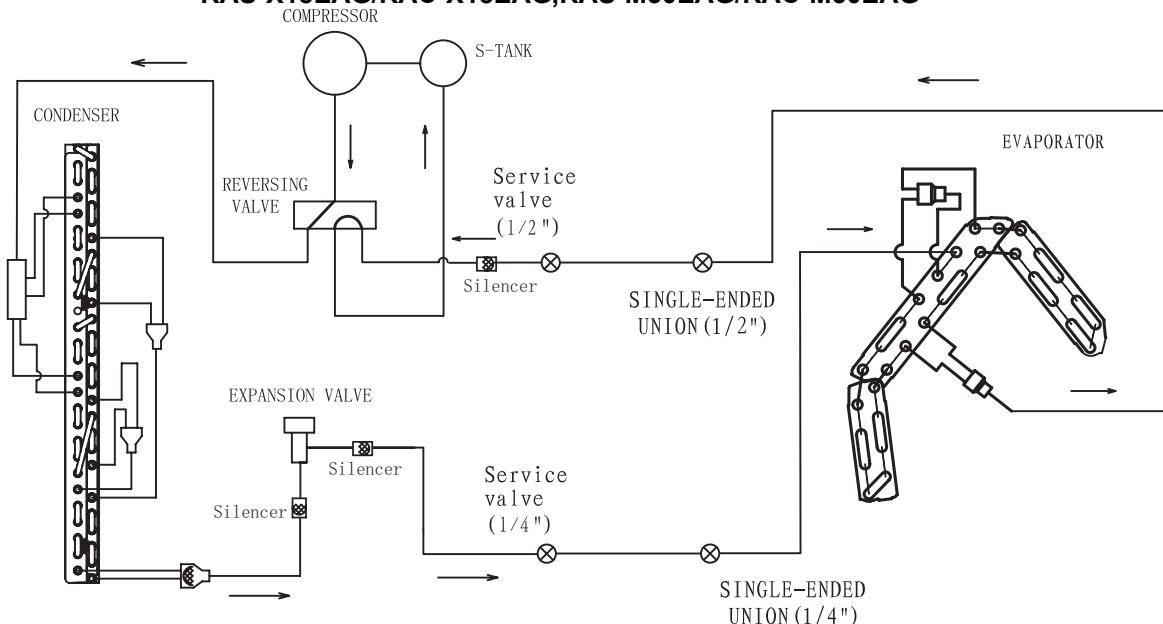

## 9 CONTROL AND FUNCTION

### 9.1. RAR-5F1



BUTTONS	FUNCTION
	<b>MODE Selector</b> Use this button to select the operations mode. Every time you press this button, the mode will change for  (HEATING),  (DEHUMIDIFYING),  (COOLING) cyclically.
	<b>FAN SPEED Selector Button</b> This determines the fan speed. Every time you press this button, the airflow rate will change from  (AUTO) →  (HIGH) →  (MED) →  (LOW) →  (SILENT) (This button allows selection of optimal or preferred fan speed for each operation mode).
<b>OFF</b>	<b>STOP button</b> Press this button to stop operation.
	<b>ECO button</b> Use this button to set the ECO mode.
	<b>POWERFUL button</b> Use this button to set the POWERFUL mode.
	<b>TEMPERATURE button</b> Value will change quicker when keep pressing.
	<b>AUTO SWING (Vertical) button</b> Controls the angle of the horizontal air deflector.
	<b>ON TIMER button</b> Select the turn ON time.
	<b>OFF TIMER button</b> Select the turn OFF time.

For more information, please refer to the operation manual.



9.2. SHIFT VALUE

1. Press and hold (OFF) button and (ON) button.
2. Press [RESET] button on the same time. Release [RESET] button only, then release (OFF) and (ON) button once Screen 1 appears.

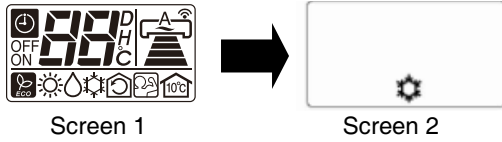

3. Press the (DEHUMIDIFYING) button to display (FAN SPEED) as in Screen 3.

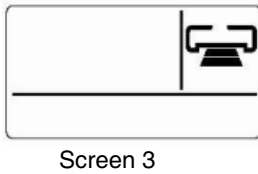

4. Press the Temperature button ( or ) to change the shift value. (The shift value is changed with a beep.)

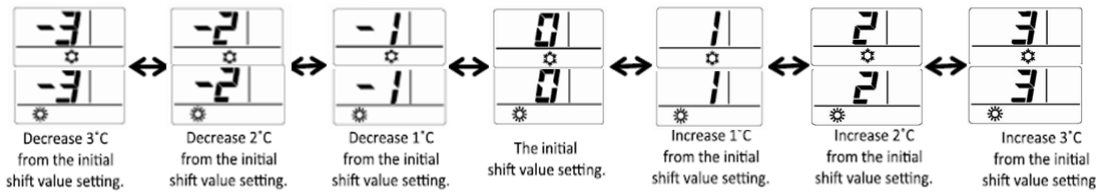

5. Select (FAN SPEED) button to choose Heating Shift or Cooling Shift Mode (Screen 4).

By setting fan speed to HIGH or MED , it will go to Cooling Shift mode.  
 By setting fan speed to LOW or SILENT , it will go to Heating Shift mode.

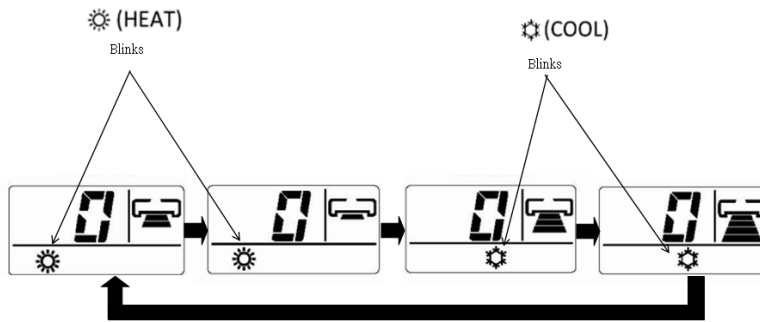

Screen 4

NOTE:

1. There are total of 7 shift values ranging from -3 to 3.
2. The displayed shift value, (HEAT) and (COOL) symbol on the remote controller display will be disappear after 10 seconds
3. The changed shift value will remain unchanged after turned off the power.
4. If "0" is displayed on the remote controller display, it indicates the shift value is now at the initial setting.

### 9.3. SETTING THE PREVENTION OF MUTUAL INTERFERENCE

- a) Please ensure that the other indoor unit is OFF and the dip switch pin NO.6 at the indoor unit is ON to set the indoor unit ID communication channel to channel B. *(Please refer to Chapter 9.4 for more information regarding the dip switch)*
- b) Open the cover/case of the remote controller and remove the PCB board as in Screen 1.

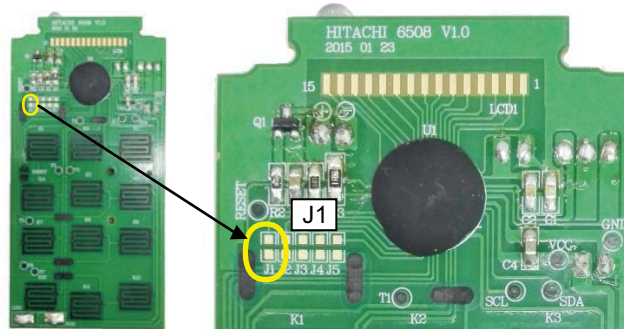

Screen 1

- c) Solder to short soldering point J1 on the PWB board's surface as in Screen 2 (before) to become Screen 3 (after).

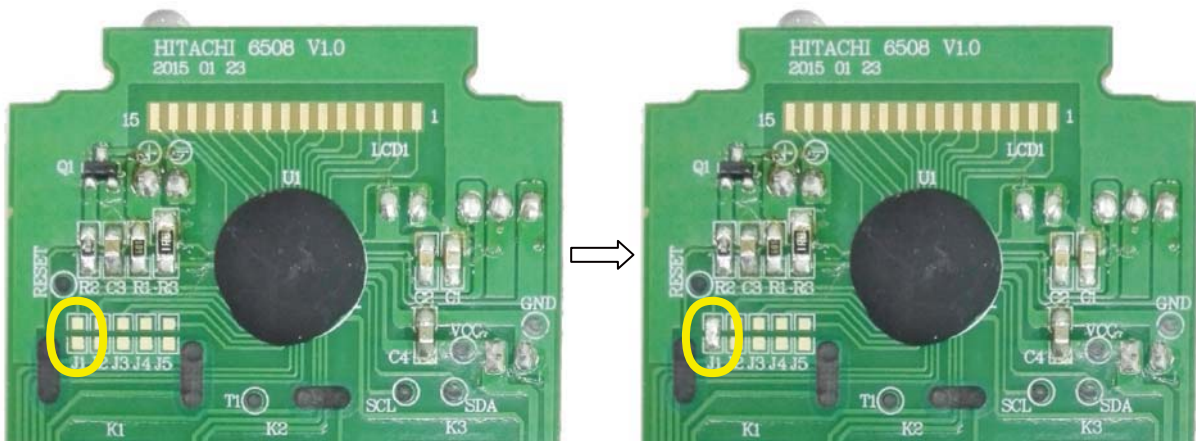

Screen 2 (Channel A)

Screen 3 (Channel B)

- d) Assemble back the remote controller and reinstall it.

### 9.4. ADDITIONAL FUNCTION VIA DIP-SWITCH SETTINGS

A new DIP Switch is available on the PWBs of the indoor unit that provide additional functions via the settings on the switches.

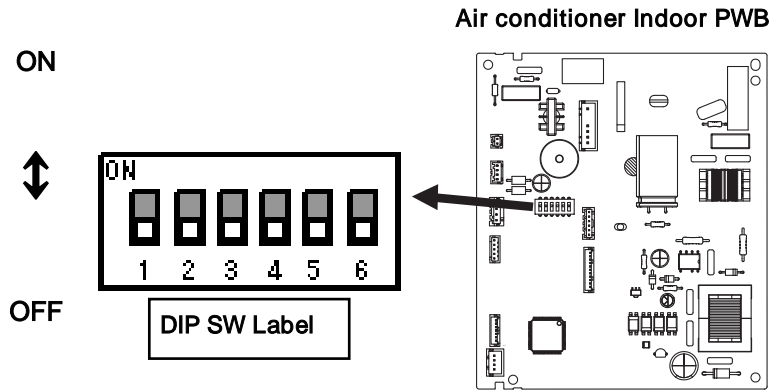

SW No.	I T E M	F U N C T I O N							
		OFF*	ENABLE	ON	DISABLE				
1	AUTO RESTART	OFF*	ENABLE	ON	DISABLE				
2	CARD KEY MODE	OFF*	DISABLE	ON	ENABLE				
3	CARD KEY LOGIC SELECT	OFF*	INPUT HIGH ACTIVE	ON	INPUT LOW ACTIVE				
4	HEATING/COOLING ONLY MODE SELECT	OFF*	HEATING & COOLING	OFF	HEATING ONLY	ON	COOLING ONLY	ON	HEATING & COOLING
5	HEATING/COOLING ONLY MODE SELECT	OFF*		ON		OFF		ON	
6	REMOCON ID SELECT	OFF*	SELECT ID : A	ON	SELECT ID : B				

NOTE:

\* Marking is position of shipping [FACTORY default setting]

#### 9.4.1. AUTO RESTART FUNCTION

The AUTO RESTART function can be enabled or disabled by setting Pin No. 1 on the DIP SWITCH above to the ON or OFF position accordingly.





















#### 9.4.2. HEATING/COOLING ONLY MODEL SELECTION

When this function is enabled, the operation mode could be locked to either Heating Only (Heating or Fan) or Cooling Only (Cooling, Fan or Dehumidifying) by setting the Pin No. 4 and 5 accordingly.





LOCKED MODE	REMARKS
HEATING ONLY	Unit will not enter into Cooling mode although cooling mode is selected using the remote controller.
COOLING ONLY	Unit will not enter into Heating mode although heating mode is selected using the remote controller.

## 10 OPTION LIST

### 10.1 WIRED REMOTE CONTROL



	BUTTONS	FUNCTION
 <p>RAR-5G2 (SPX-RCDB)</p>		<b>MODE Selector</b> Use this button to select the operating mode. Every time you press this button, the mode will change from  (AUTO) →  (HEAT) →  (DEHUMIDIFY) →  (COOL) and →  (FAN) cyclically.
		<b>FAN SPEED Selector Button</b> This determines the fan speed. Every time you press this button, the airflow rate will change from  (AUTO) →  (HIGH) →  (MED) →  (LOW) →  (SILENT) (This button allows selection of optimal or preferred fan speed for each operation mode).
		<b>ON/OFF button</b> Press this button to start operation. Press it again to stop operation.
		<b>SLEEP button</b> Use this button to set the SLEEP timer.
		<b>SET button</b> Timer setting reservation.
		<b>OFF button</b> Select the turn OFF timer.
		<b>ON button</b> Select the turn ON timer.
		<b>CANCEL button</b> Cancel timer reservation.
		<b>AUTO SWING (Vertical) button</b> Controls the angle of the horizontal air deflector.
		<b>ROOM TEMPERATURE setting button</b> Value will change quicke when keep pressing.

#### 10.1.1 SHIFT VALUE

1. Press and hold  (ON/OFF) button and  (ON TIMER) button at the same time while giving a single press on the RESET button until remote controller now enter 'Shift value change mode'.
2. Press  (ON/OFF) button so that the display indicates  (FAN) speed.
3. Select  (FAN SPEED) button to choose Heating Shift or Cooling Shift Mode.

By setting fan speed to HIGH  or MED  , it will go to Cooling Shift mode.

By setting fan speed to LOW  or SILENT  , it will go to Heating Shift mode.



4. Press  (ROOM TEMPERATURE) button to change the shift value (-3°C ~ 0 ~ 3°C).
5. Press  (ON/OFF) button to end 'Shift value setting mode'.



#### NOTE:

1. There are total of 7 shift values ranging from -3 to 3.
2. The changed shift value will remain unchanged after turned off the power.

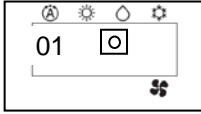
### 10.1.2 ERROR CODE INFORMATION

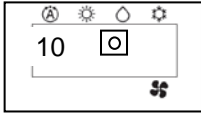
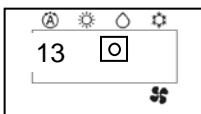
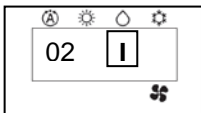
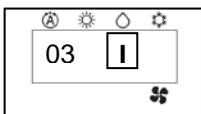
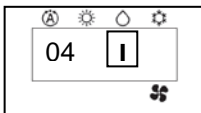
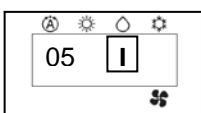
1. In case failure occurs to the air conditioner, the error code will constantly appear on the wired remote controller display.

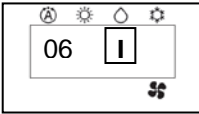
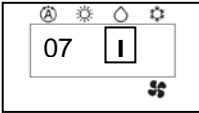
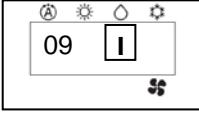
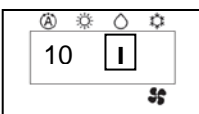
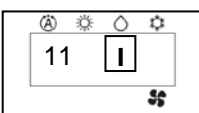
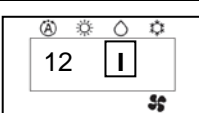
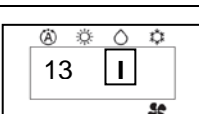
	TIMER LAMP BLINKING	LD301 BLINKING	CODE	MEANING
INDOOR	-	-	-	Normal
	1 time	-		Refrigerant cycle fault
	2 times	-	-	Outdoor unit is under forced operation
	3 times	9 times		Communication error between indoor and outdoor units
	9 times	-		Indoor thermistor defective
	10 times	-		Abnormal rotating numbers
	13 times	-		IC401 data reading error
OUTDOOR	4 times	2 times		Peak current cut
	4 times	3 times		Compressor abnormal low speed rotation
	4 times	4 times		Compressor switching failure
	4 times	5 times		Overload lower limit cut

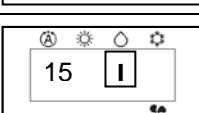
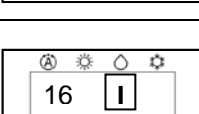
	TIMER LAMP BLINKING	LD301 BLINKING	CODE	MEANING
OUTDOOR	4 times	6 times		OH thermistor temperature rise
	4 times	7 times		Abnormal outdoor thermistor
	4 times	9 times		Communication error
	4 times	10 times		Abnormal power source
	4 times	11 times		Fan stop for strong wind
	4 times	12 times		Fan motor fault
	4 times	13 times		EEPROM reading error
	4 times	14 times		Active converter defective
	4 times	15 times		Abnormal PWB circuit
	4 times	16 times		High load stop

## 10.2 H-LINK ADAPTOR

### 10.2.1 SAFETY SUMMARY

**DANGER:**

- DO NOT pour water into the remote control switch (hereafter called "controller"). This product is equipped with electrical parts. This will cause serious electrical shock.

**WARNING:**

- DO NOT perform installation work and electrical wiring connection by yourself. Contact your distributor or dealer of HITACHI and ask them for installation work and electrical wiring by service person. The specified cable should be used to connect (i) room air conditioner and adaptor, and (ii) controller and adaptor.



**CAUTION:**



- DO NOT install the indoor unit, outdoor unit, controller and cable as such places as:
  - where there is oil vapor and dispersion of oil
  - where there is sulfuric environment (near the hot springs)
  - where there is a flammable gas
  - where there is salty environment (near the sea)
- DO NOT install the indoor unit, outdoor unit, controller and cable within approximately 3 meters from strong electromagnetic wave radiators, such as medical equipment. In case that the controller is installed in a place where there is electromagnetic wave direct-radiation, shield the controller and cables by covering with the steel box and running the cable through the metal conduit tube.
- In case that there is electric noise at the power source for the indoor unit, provide a noise filter.

### 10.2.2 INSTALLATION WORK

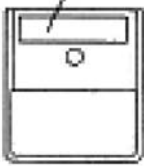
■ Before installation

Check the contents and the number of the accessories in the packing.

Adaptor	 <p>With two 1.8m cables</p>
1 piece of cover for hiding the covering	 <p>Attached 2 sided tapes</p>
Two-sided tape for attaching to Adaptor	 <p>110x40x3mm</p>

2 connectors for H-Link connection		
2 tapping screws for attaching to wall		φ3.0 x 10mm
2 screws for attaching to wooden wall		φ3.1 x 16mm

- 1) RAC adaptor can be installed to the wall as well as on the air conditioner itself
- 2) Install RAC adaptor in the vertical surface as shown below.

Upper side

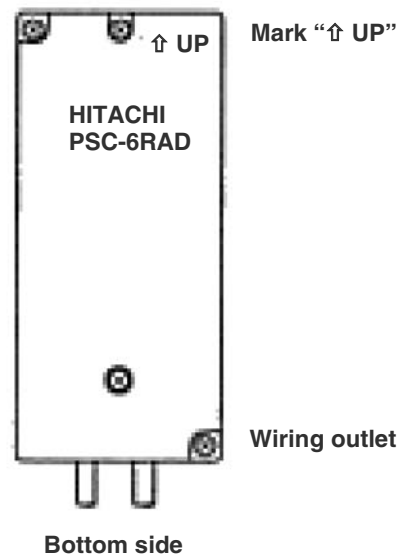

- 3) Installation procedure
  - a) When installing to the wall.
    - i) Fix the adaptor with 2 screws. Tapping screw is for metal surface, and other screw is for wooden surface.

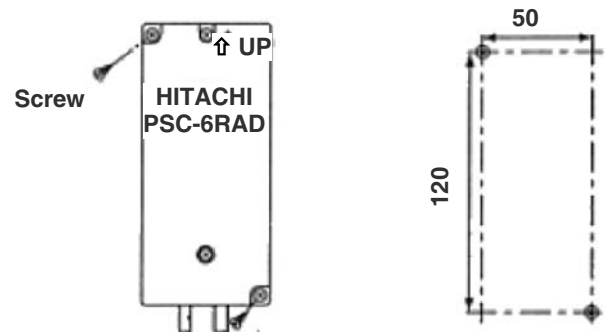

- ii) When using the cover It can be installed at the right and left side of room air conditioner. Fix the cover and RAC adaptor with the two-sided tape (accessory).

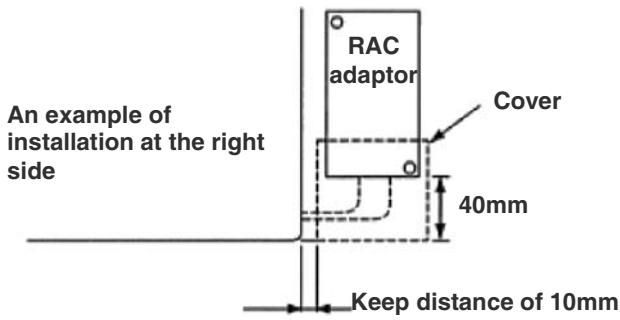

An example of installation at the right side

- b) When installing on the room air-conditioner
- In case that it cannot be installed to the wall due to the space or material problem, install the RAC adaptor with the two-sided tape (accessory) on the room air-conditioner.
- Confirm if the piping cover of the unit can be removed when performing the service maintenance, and then fix the RAC adaptor in the side of room air-conditioner with two-sided tape. (Available at the right as well as left side)
  - Clean the surface to be installed with a dry cloth.

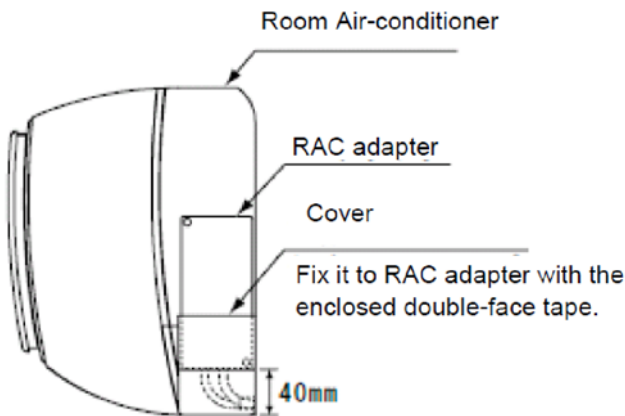

**NOTE:**

- Consider the following points since the adhesiveness changes according to the environmental conditions (temperature, humidity etc)
- The adhesiveness is decreased when there is humidity or oil.
- Warm the adhesive part and installation place of the two-sided tape to avoid the decrease of the adhesiveness in case the ambient temperature is low.
- DO NOT touch the adhesive part by fingers nor re-attach it many times. The adhesiveness has decreased and the RAC adaptor may fall off.
- DO NOT apply any force within 24 hours after installation.

### 10.2.3 ELECTRICAL WIRING

#### ■ System configuration

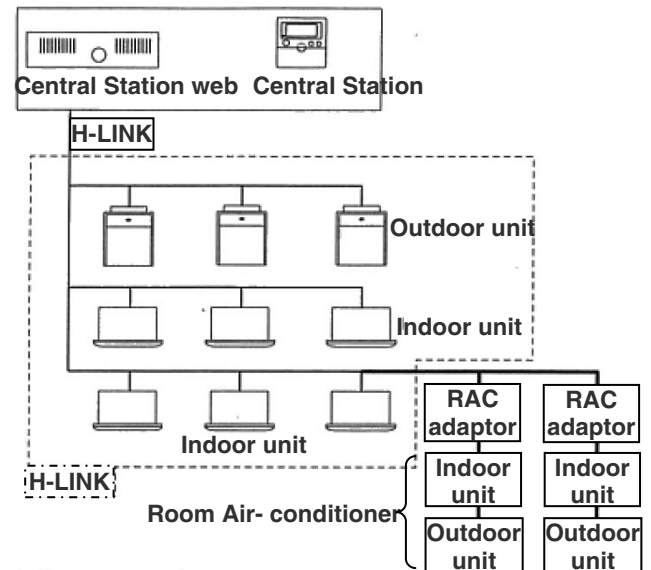

**CAUTION:**

- Turn OFF the power supply of the room air-conditioner of the central control device when performing the wiring work
- DO NOT run all the H-LINK cable or power supply cable along the other signal cable, or malfunction may occur due to the noise, etc. If it is required to run along the other transmission cable, separate the cable more than 30cm, or run the cable through the metal tube and earth the tube.
- Follow local codes and regulations when performing electrical wiring and earth wiring.
- Transmissions cable used in H-LINK shall be 2 cores cable ( $0.7\text{mm}^2$  to  $1.25\text{mm}^2$  for model: VCTF, VCT, CVV, MVVX, CVVX, VVR, VVF) or 2 cores twisted pair cable (model: KPEV, KPEV-Spec). Total length of cable shall be below 1000mm.
- DO NOT use wire with more than 3 cores.

#### ■ Internal components and Wiring connections

Check the contents and the number of the accessories in the packing.

- Access  
Open the cover by removing the ① and ② screws.



- Wiring Connection  
Connection with Room Air-Conditioner
  - Remove the front cover of the room air-conditioner and the cover of electrical box.
  - The cable attached with the connector of the RAC adaptor shall be connected with the connector of indoor PCB



- iii) Install the electrical box cover paying attention not to clamp the cable. Read the installation manual of each room air-conditioner for confirming how to connect and how to assemble the cable of the RAC adaptor.

**CAUTION:**

- Disconnect the power plug before performing this work
- Turn OFF the break power source in case the power is supplied from the outdoor unit.
- Connection of Transmission Cable  
H-LINK transmission cable connecting to RAC adaptor shall be connected to H-LINK.

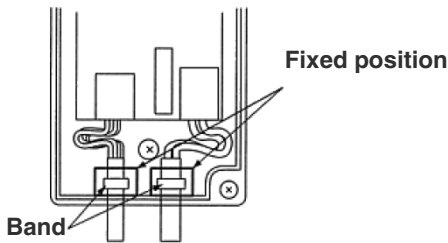
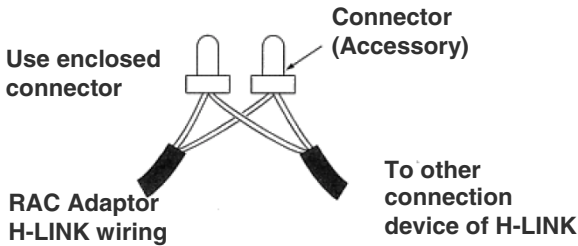

**CAUTION:**

- DO NOT connect incorrect wiring. It may cause the failure of the RAC Adaptor. Especially pay attention not to apply high voltage e.g. AC400/230V.
- DO NOT perform the wiring work while power to the central station or the RAC Adaptor is still being supplied. It may cause malfunction. Turn OFF devices when performing the wiring work.
- The RAC Adaptor side cable should not overload to the connector.
- DO NOT clamp the cable when attaching the RAC adaptor cover.
- Band should not be loose and in fixed position.

**10.2.4 DIP SWITCH SETTING**

- 1) Switch OFF the power of room air conditioner before setting the DIP switch. If the power is ON, the settings are INVALID.
- 2) The position of the DIP switch is shown below.

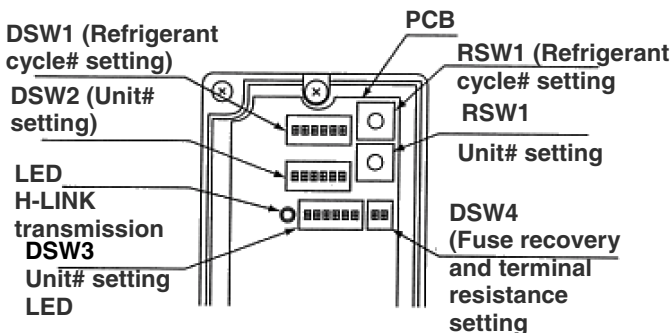

**CAUTION:**

- DO NOT turn ON various pins of DSW1 and DSW2

- 3) Set the refrigerant cycle# by RSW1 and DSW1

DSW1 (Ten digit)	RSW1 (Last digit)
DSW1 and RSW1 are set "0" before shipment. Up to 15 cycles can be set. E.g. Setting in Ref No. 5	
No. 1 pin is OFF	The position is Set 5

- 4) Set the unit No. by RSW2 and DSW2

DSW2 (Ten digit)	RSW2 (Last digit)
DSW2 and RSW3 are set "0" before shipment. Up to 15 cycles can be set. E.g. Setting in Unit No. 15	
No. 1 pin is OFF	The position is Set 5

- 5) Slave unit.

In case of setting various RAC adaptors in the same refrigerant cycle, set the RAC adaptor with smallest Unit# as a master unit. In case of setting only one RAC adaptor in a refrigerant system, this adaptor should be a master unit. Set this procedure by DSW3.

Master Unit setting	Setting before shipping (slave unit setting)

●: Master Unit setting

○: Setting before Shipping (Slave Unit setting)

		Indoor Unit#							
		0	1	2	3	4	5	6	7
Refrigerant Unit#	0	●	○	○	○	○			
	1			●	○	○			
	2				●	○	○	○	○
	3		●						
	4								

**CAUTION:**

– DO NOT set various main adaptors in the same refrigerant cycle.

- 6) Procedure when applying 200V voltage to H-LINK wiring incorrectly.

In case of applying 200V voltage to H-LINK wiring incorrectly, the fuse installed in a transmission circuit on PCB will blow out. In this case, reconnect the wiring correctly and turn ON No. 2 pin of DSW4 on PCB. The transmission circuit can be recovered. (If applying this error again, the transmission circuit can not be recovered)

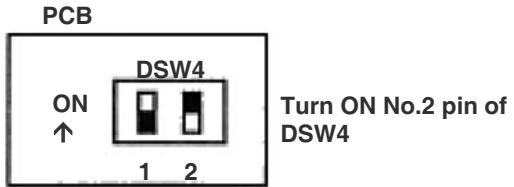

- 7) Terminating resistance is set in whole H-LINK system.
  - a) If H-LINK connecting devices like package air-conditioner are connected besides the RAC Adaptor, set the terminating resistance by those connecting devices. The terminating resistance should be set ON in only one position in whole H-LINK system.
  - b) In case that H-LINK is connected only by the RAC adaptor, set the terminating resistance by the RAC adaptor. The terminating resistance should be set ON in only one position in whole H-LINK system.

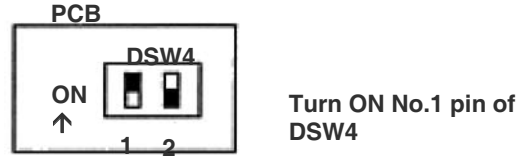

**10.2.5 TEST RUN**

Test run should be performed in the following after finishing the installation, wiring and setting. Refer to the installation manuals enclosed with the control system equipment.

- 1) Confirmation of RAC Adaptor Connection  
Confirm if the RAC adaptor connection is recognized in the control system equipments. In case that it is not confirmed, check the transmission cable, refrigerant cycle #, indoor unit #, terminal resistance setting etc.
- 2) Registration  
Confirm if the RAC adaptor connection is recognized.
- 3) Confirmation of RUN/STOP Operation.  
Confirm if the room air-conditioner operate correctly by RUN/STOP from the central control system equipments. Check also if the room air-conditioner operation changes correctly by each setting.

### 10.3 DRY CONTACT APPLICATION (USING DIP SWITCH)

The dry contact system enables the operation of the air conditioner indoor unit to be controlled by using external dry contacts (with non voltage) such as card-key controller or window for facilities such as hotels.

Note:

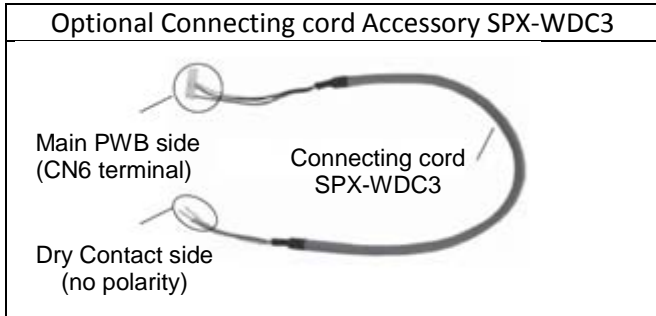

- 1) AUTO RESTART function set to "Enable" is needed (set pin#1 on the DIP SWITCH SW501 above to OFF position).
- 2) DRY CONTACT function is "Enable" by set pin No. 2 of the DIP SWITCH (DSW1) to ON position.
- 3) Select the proper setting for DRY CONTACT LOGIC INPUT pin No. 3 on DIP SWITCH (DSW1)
  - i) Set to OFF position (Hi Input) if the type of Dry Contact switch to be used (for the CARD KEY UNIT or Window) is of contact type a (Normally Open Type) as shown in below diagram.
  - ii) Set to ON position (Lo Input) if the type of Dry contact switch to be used (for the CARD KEY UNIT or Window) is of contact type b (Normally Close Type) as shown in below diagram.

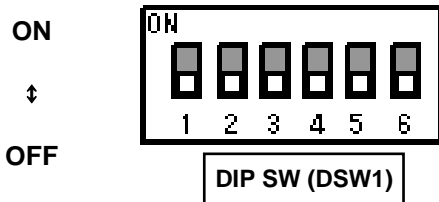

Pin No.	Function	Switch Position / Setting			
		OFF	Disable	ON	Enable
2	DRY CONTACT function	OFF	Disable	ON	Enable
3	DRY CONTACT Input Logic	OFF	HI Input Active	ON	LO Input Active

- Please decide the type of dry contact you will be using and set the position of the DIP Switch No. 2 and 3 accordingly

[1] CHECK DRY CONTACT OF CARD KEY UNIT

	AIR CONDITIONER Standby	AIR CONDITIONER Operating
	CARD KEY (Door Switch)	REMOVE 
Contact type a	OPEN 	CLOSE 
Contact type b	CLOSE 	OPEN 

[2] SET THE POSITION OF DIP SWITCH

POSITION CONDITION OF DIP SWITCH	
INITIAL CONDITION (CARD KEY NO USE) 	No.2 : OFF No.3 : OFF
	<b>HI Input Active</b> No.2 : ON No.3 : OFF
	<b>LO Input Active</b> No.2 : ON No.3 : ON

After all connection has been done as below diagram, ON the breaker and push ON button of wireless remote controller or wired remote controller to operate the air conditioner unit.

- When the CARD KEY is in insert condition, the air conditioner operation is allowable by remote controller.
- When the dry contact switch on the Card Key Unit is open (refer to diagram below for contact type a), the unit stops to operate (it takes 10 seconds to stop the unit operation after the dry contact switch on the card key turns off) and vice versa.
- When the card key is removed from the Card Key Unit, the wireless remote controller cannot be used.
- When the card key is removed from the Card Key Unit, the wired remote controller LCD display is activated; however it has no control over the unit.
- The suitable accessory Connecting Cord (accessory code#: SPX-WDC3) need to be used to connect the Card Key Unit's dry contact switch to the connector on the control board of the indoor unit. Please refer to Table 1 to select suitable accessory code# for the concerning indoor model.

Example of wiring connection to Card Key Unit will be as below (reference only)

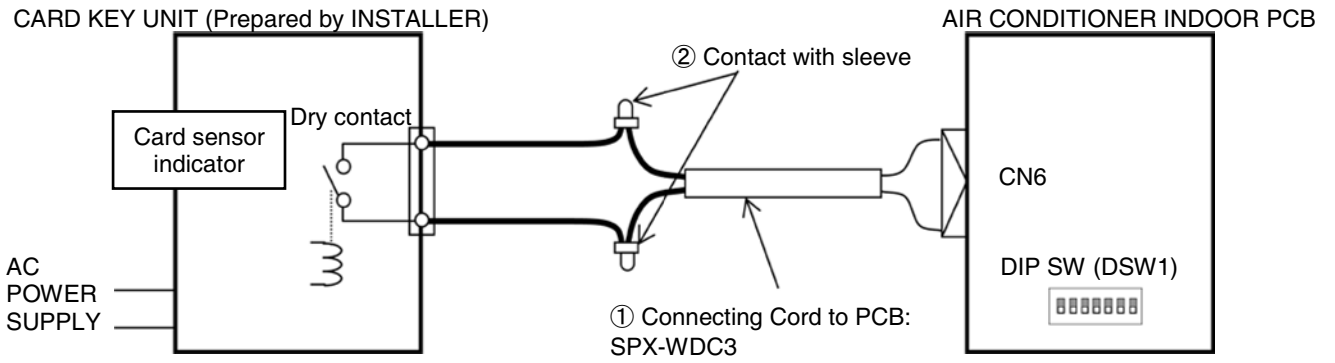

• CONNECTION EXAMPLE

i. Pin No. 3 of DIP SWITCH is set to OFF position (HI Input Active) for Dry Contact Type a

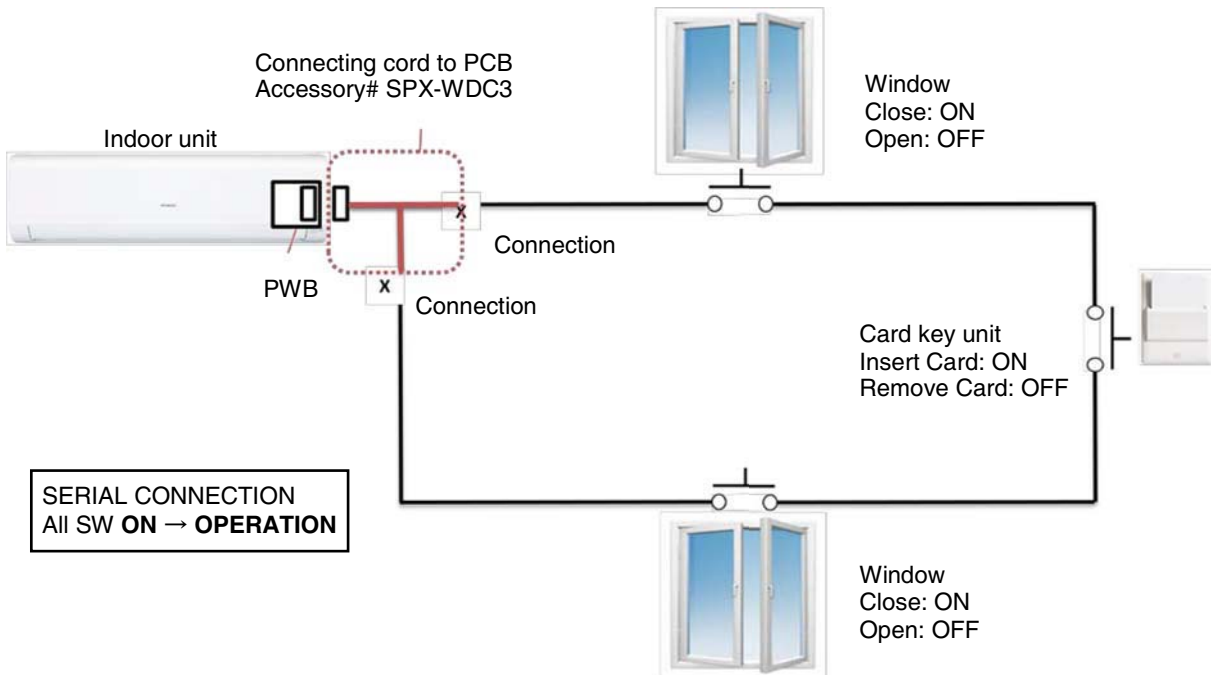

ii. Pin No. 3 of DIP SWITCH is set to ON position (LO Input Active) for Dry Contact Type b

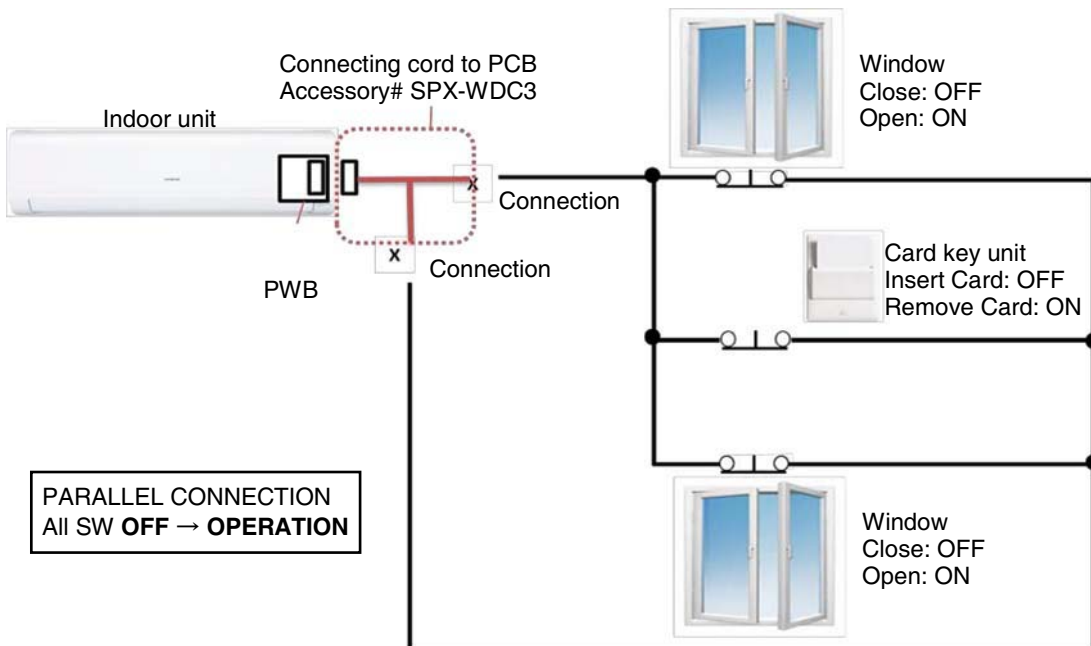

Please refer to the actual manual supplied with the optional connecting cords SPX-WDC3 for more details.

---

# HITACHI

## TC-ERP-Model

### INDOOR

RAK-18PED  
RAK-25PED/25PEDC  
RAK-35PED/35PEDC  
RAK-50PED/50PEDC  
RAS-X10/14/18EAG  
RAS-L10/14EAG  
RAS-M25/35/50EAG

### OUTDOOR

RAC-18WED  
RAC-25WED  
RAC-35WED  
RAC-50WED  
RAC-X10/14/18EAG  
RAC-L10/14EAG  
RAC-M25/35/50EAG