

LG

MULTI V Hydro Kit

R410A / R134a (50Hz/60Hz)

5CVG0-01B(Replaces 5CVG0-01A)

TOTAL HVAC SOLUTION PROVIDER

ENGINEERING PRODUCT DATA BOOK



MULTI V Indoor unit **Hydro Kit**

- **Introduction**
- **General Information**
- **Indoor Units**

1. Preface

R410A/R134a Model

MULTI V is the most favored choice when there is a need for precise air conditioning of relatively big projects extending from Multi-Room structure to big commercial places. We have a big line up, that offers wider flexibility of model selection.

Equipped with inverter technology and long piping installation, the product matches well if one talk about optimum power consumption in high rise buildings. Add on capacity feature makes it easy to upgrade the existing capacity at any time.

With the growing concern about environment preservation, **MULTI V** comes with R410A refrigerant which is environment friendly and thus our **MULTI V** system is a high technology and environment friendly product.

Unique refrigerant flow and electronic circuit control gives this system an unique capability to work in extreme/abnormal working conditions making our customer feel great about their decision of selecting LG **MULTI V** as their first choice.

This publication provides a detailed and in depth information about the design and installation of **MULTI V**.

We hope that with this information you would become an expert of your **MULTI V** system.

LG Electronics Inc.

Air Conditioning & Energy Solution Company

MULTI V Indoor unit **Hydro Kit**

General Information

- 1. Model Names & External Appearance**
- 2. Nomenclature**
- 3. Indoor Unit Capacity Index & Combination Ratio**

1. Model Names & External Appearance

■ Model Names

Category		Chassis Name	8HP	10HP
Hydro Kit	Medium Temperature	K2		ARNH10GK2A2
	High Temperature	K3	ARNH08GK3A2	

■ External Appearance

Category		Chassis Name	Model Name	Model
Hydro Kit	Medium Temperature	K2	ARNH10GK2A2	
	High Temperature	K3	ARNH08GK3A2	

2. Nomenclature

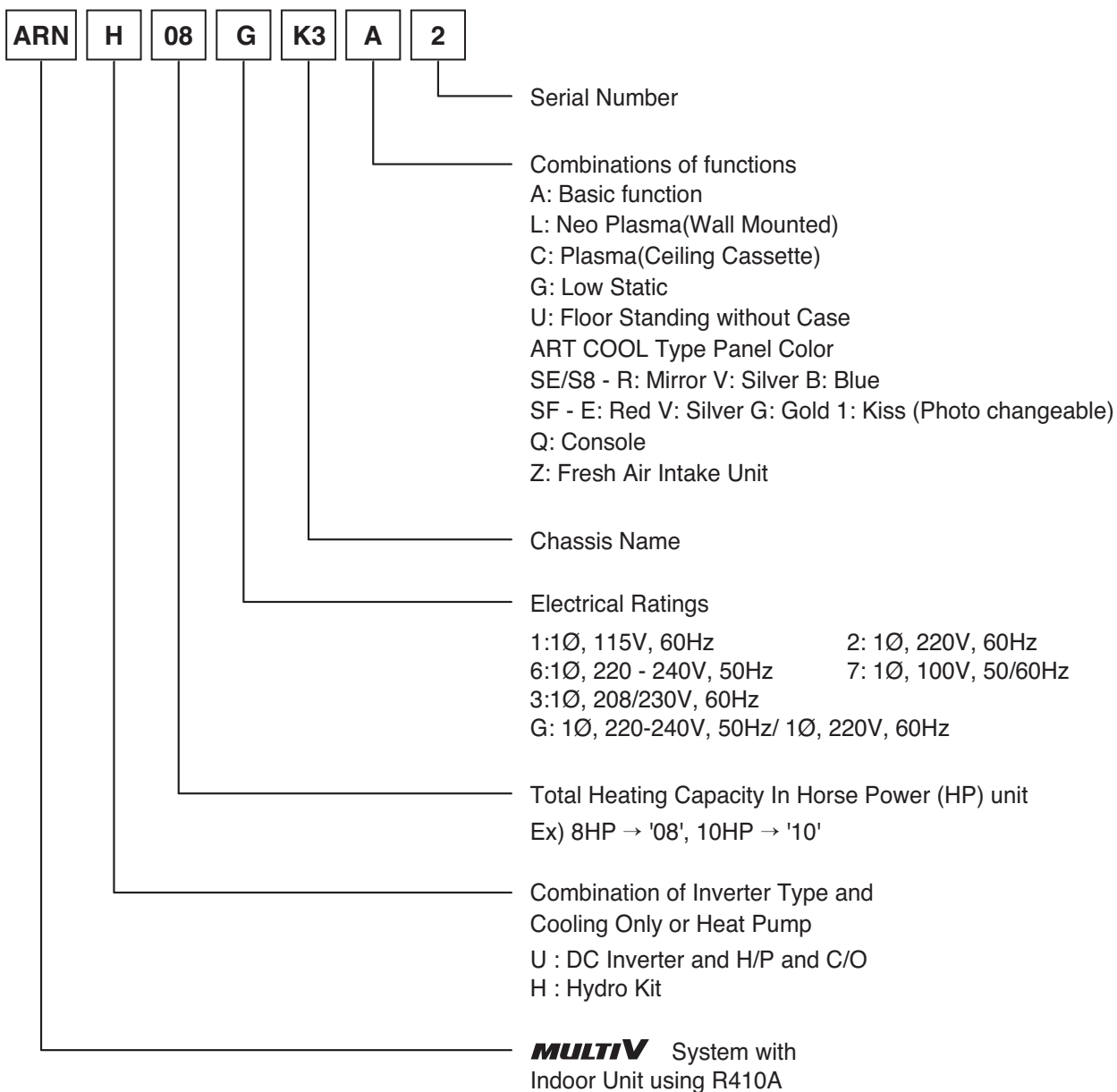

3. Indoor Unit Capacity Index & Combination Ratio

■ Indoor Unit Capacity Index

Unit Capacity (Btu/h)	76k	96k
Capacity Index	22.4	28.0

Note) Capacity Index is same as the capacity(kW).

■ Indoor Unit Combination Ratio

Indoor Unit Outdoor Unit	Only ARNH-series	ARNH-series with Multi V indoor units	Only Multi V indoor units*
Multi V III Multi V III Heat Recovery Multi V Water II Multi V Water II Heat Recovery Multi V Geo	50 ~ 100%	50~130%	50 ~ 200%

Note) *:Refer to the outdoor unit PDB for details about only Multi V indoor units combinations.

MULTI V Indoor unit **Hydro Kit**

Indoor unit

- 1. Hydro Kit (Medium Temp.)**
- 2. Hydro Kit (High Temp.)**

MULTI V Indoor unit **Hydro Kit**

Hydro Kit (Medium Temp.)

- 1. List of functions**
- 2. Specifications**
- 3. Dimensions**
- 4. Piping Diagrams**
- 5. Wiring Diagrams**
- 6. Capacity correction factor**
- 7. Water Pressure Drop**
- 8. Operation Limits**
- 9. Electric Characteristics**
- 10. Sound Levels**
- 11. Installation**
- 12. Accessories Installation**
- 13. System Set-Up**
- 14. Test Run**

1. List of functions

1.1 List of functions

Category	Functions	ARNH10GK2A2
Installation	Drain pump	X
	E.S.P. control	X
	Electric heater	X
	High ceiling operation	X
	Auto Elevation Grille	X
Reliability	Hot start	X
	Self diagnosis	O
	Soft dry operation	X
Convenience	Auto changeover	X
	Auto cleaning	X
	Auto operation(artificial intelligence)	X
	Auto Restart	O
	Child lock	O
	Forced operation	X
	Group control	O
	Sleep mode	X
	Timer(on/off)	O
Timer(weekly)	O	
Individual control	Two thermistor control	X
	Standard Wired remote controller	O
	Deluxe wired remote controller	X
	Simple wired remote controller	X
	Simple Wired remote controller(for hotel use)	X
CAC network function	Wireless remote controller	X
	General central controller (Non LGAP)	X
	Network Solution(LGAP)	O
	Dry contact	PQDSA(1) / PQDSB(1)
	PDI(power distribution indicator)	X
Special function kit	PI 485	X
	Zone controller	X
	CTI(Communication transfer interface)	X
Others	Electronic thermostat	X
	Remote temperature sensor	PQRSTA0
Hydro Kit	Telecom shelter controller	X
	Anti-condensation on floor(cooling)	O
	Water pump on / off Control	O
	Flow switch control	O
	Thermostat interface (230V AC)	O
	Thermostat interface (24V AC)	O
	Sanitary tank heating	O
	Solar-thermal interface with sanitary tank	O
	PHEX anti-freezing control	O
	Water pump forced operation	O
	Autosetting according to ambient temperature	O
	Silent operation	X
	Anti-overheating of water pipe	O
Emergency operation	O	

Notes

O : Applied, X : Not applied

Accessory model name : Installed at field, ordered and purchased separately by the corresponding model name, supplied with separate package.

1. List of functions

1.2 Accessory List

Device		ARNH10GK2A2
Central Controller	Simple Controller	X
	Function controller	X
	Function Scheduler	X
	AC Ez	X
	AC Smart II	PQCSW320A1E
	128 Unit Expansion Kit	PQCSE440U0
	Option Kit (SD card type)	PQCSE341A0
	ACP(Advanced Control Platform)	PQCPA11A0E
	AC Manager	PQCSS520A0E
	DO(Digital Output) Kit	X

Notes

O : Applied, X : Not applied

Accessory model name : Installed at field, ordered and purchased separately by the corresponding model name, supplied with separate package.

2. Specifications

Type				Hydro Kit (Medium Temp.)
Model		Unit		ARNH10GK2A2
Power Supply		V / Ø / Hz		220-240 / 1 / 50
				220 / 1 / 60
Capacity (Rated)	Cooling	kW		28.0
		kcal/h		24,100
		Btu/h		95,900
	Heating	kW		31.5
		kcal/h		27,100
Btu/h		107,500		
Input (Rated)	Cooling	kW		0.01
	Heating	kW		0.01
Casing				Painted Steel Plate
Dimensions	Body	W x H x D	mm	520 x 631 x 330
			inch	20-15/32 x 24-27/32 x 13
Net Weight	Body		kg (lbs)	35.0 (77.2)
Heat Exchanger	Refrigerant to Water	Type		Brazed Plate HEX
		Quantity	EA	1
		Number of Plate	EA	48
		Rated Water Flow	l/min	46.0
		Head Loss	kPa	25.0
Temperature Control				Microprocessor, Thermostat for cooling and heating
Sound Absorbing Thermal Insulation Material				Foamed polystyrene
Safety Device				Fuse
Piping Connections	Water Side	Inlet	inch	Male PT 1
		Outlet	inch	Male PT 1
	Refrigerant Side	Liquid	mm(inch)	Ø 9.52(3/8)
		Gas	mm(inch)	Ø 22.2(7/8)
Drain Piping Connection			inch	Male PT 1
Sound Pressure Level	Cooling		dB(A)	26
	Heating		dB(A)	26
Power Supply Cable			No. x mm ²	3C x CV2.5
Communication cable			No. x mm ²	2C x CVV-SB 1.0~1.5
Refrigerant	Refrigerant to Water	Refrigerant name		R410A
		Precharged Amount	kg (lbs)	-
		Control		Electronic Expansion Valve

Notes:

1. Capacities are based on the following conditions:

- Cooling Temperature : Indoor 27°C(80.6°F) DB / 19°C(66.2°F) WB
 Outdoor 35°C(95°F) DB / 24°C(75.2°F) WB
 Water Inlet 23°C(73.4°F) / Outlet 18°C(64.4°F)
- Heating Temperature : Indoor 20°C(68°F) DB / 15°C(59°F) WB
 Outdoor 7°C(44.6°F) DB / 6°C(42.8°F) WB
 Water Inlet 30°C(86°F) / Outlet 35°C(95°F)
- Piping Length : Interconnected Pipe Length = 7.5m
- Difference Limit of Elevation (Outdoor ~ Indoor Unit) is Zero.

2. Wiring cable size must comply with the applicable local and national code.

3. Due to our policy of innovation, some specifications may be changed without notification.

4. Sound Level Values are measured at Anechoic chamber.

Therefore, these values can be increased (maximum 3dB(A)) owing to ambient conditions during operation.

MULTI V Indoor unit
Hydro Kit
3. Dimensions

[Unit: mm]

K2 Chassis
ARNH10GK2A2

3D View

Note

1. Unit should be installed in compliance with the installation manual in the product box.
2. Unit should be grounded in accordance with the local regulations or applicable national codes.
3. All electrical components and materials to be supplied from the site must comply with the local regulations or international codes.

No.	Part Name	Description
7	Power Supply Cable	∅ 40
6	Communication Cable	∅ 30
5	Drain Pipe	-
4	Water Outlet	-
3	Water Inlet	-
2	Gas Pipe	-
1	Liquid Pipe	-

4. Piping Diagrams

ARNH10GK2A2 (Medium Temperature)

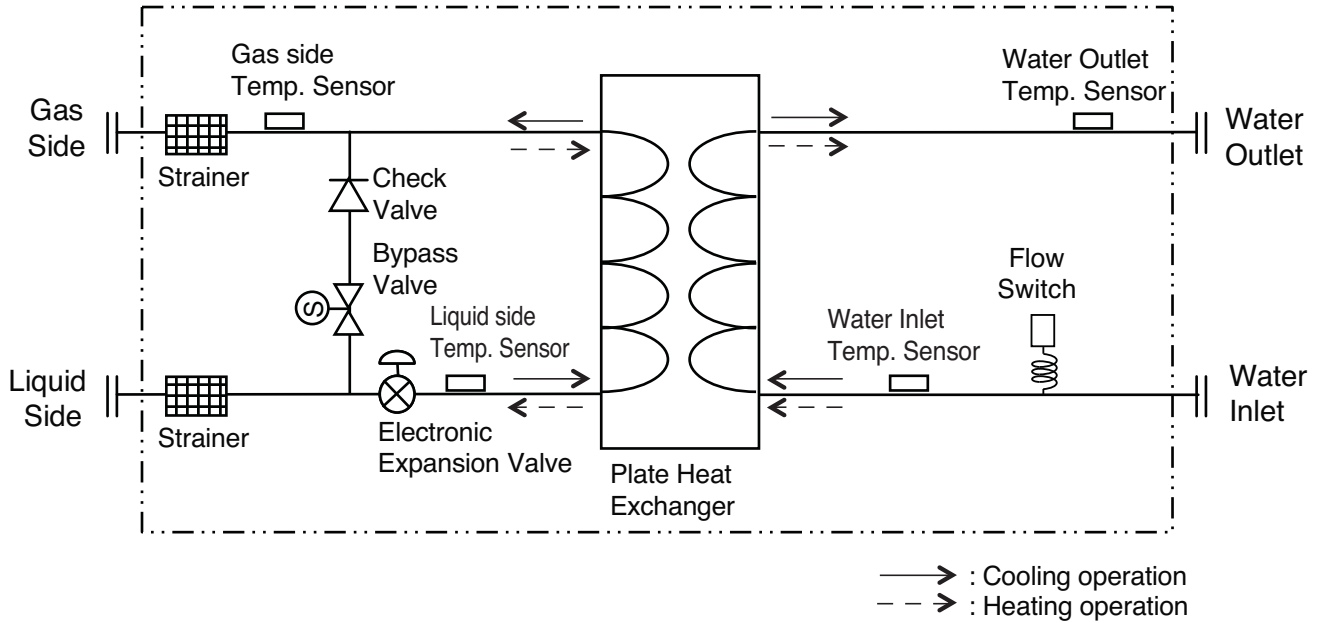

Description	PCB Connector	Remarks
Air Temperature Sensor	CN_ROOM	- Optional Accessory (being sole separately) - Not shown in diagram
Gas side Temperature Sensor	CN_PIPE/OUT	
Liquid side Temperature Sensor	CN_PIPE/IN	
Water Inlet Temperature Sensor	CN_TH3	- Water Inlet and Water Outlet sensors connected to 4 pin type connector CN_TH3
Water Outlet Temperature Sensor		

MULTI V Indoor unit
Hydro Kit
5. Wiring Diagram

ARNH10GK2A2

Hydro Kit (Medium Temp.)

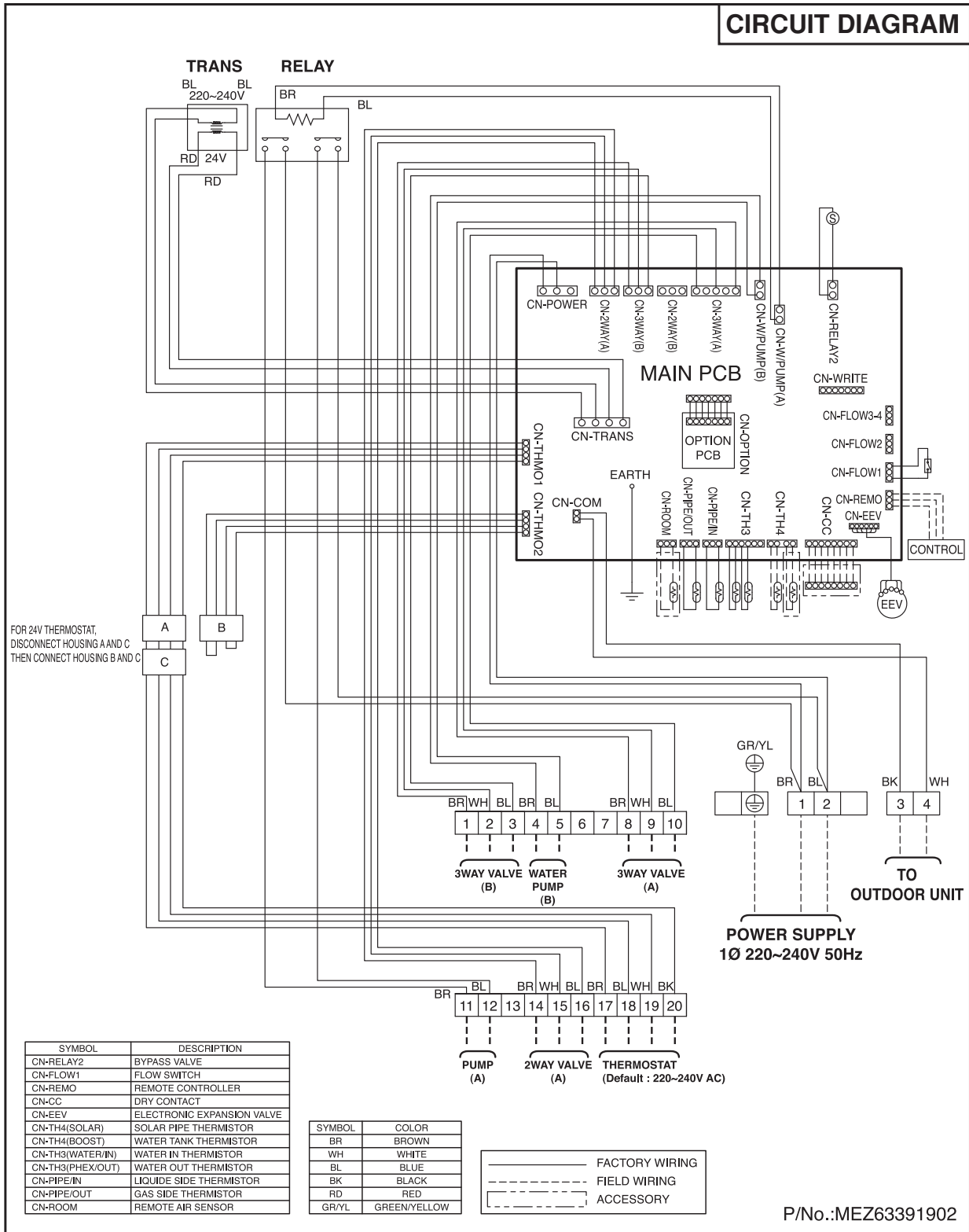

6. Capacity correction factor

6.1 Capacity correction factor by temperature

6.1.1 ARNH10GK2A2 (Cooling)

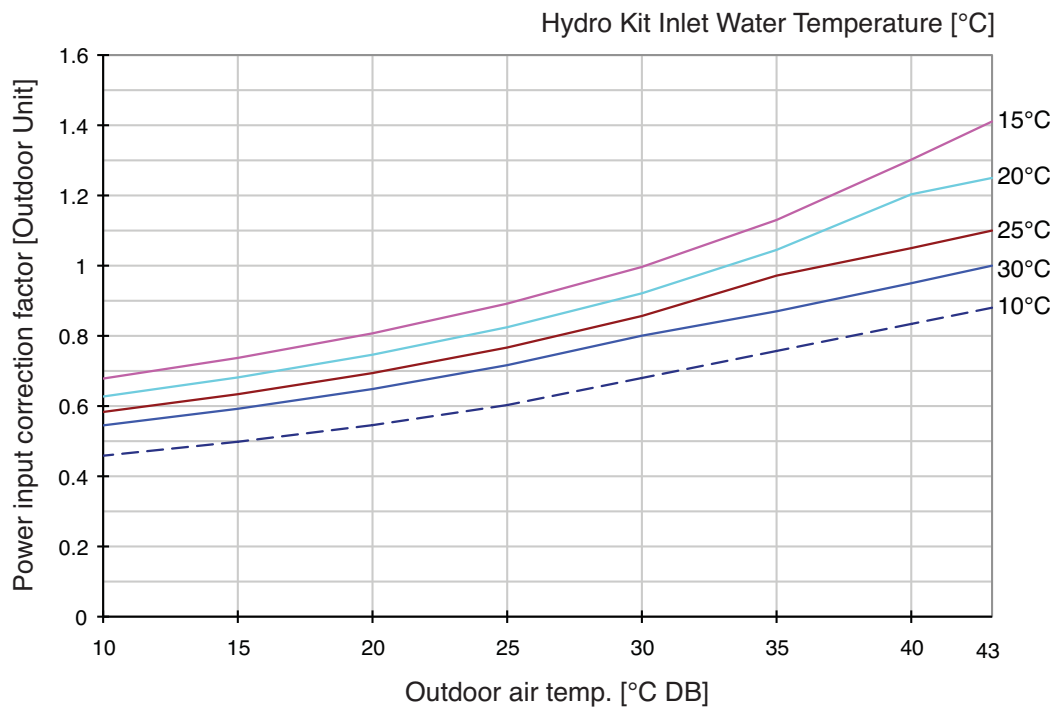
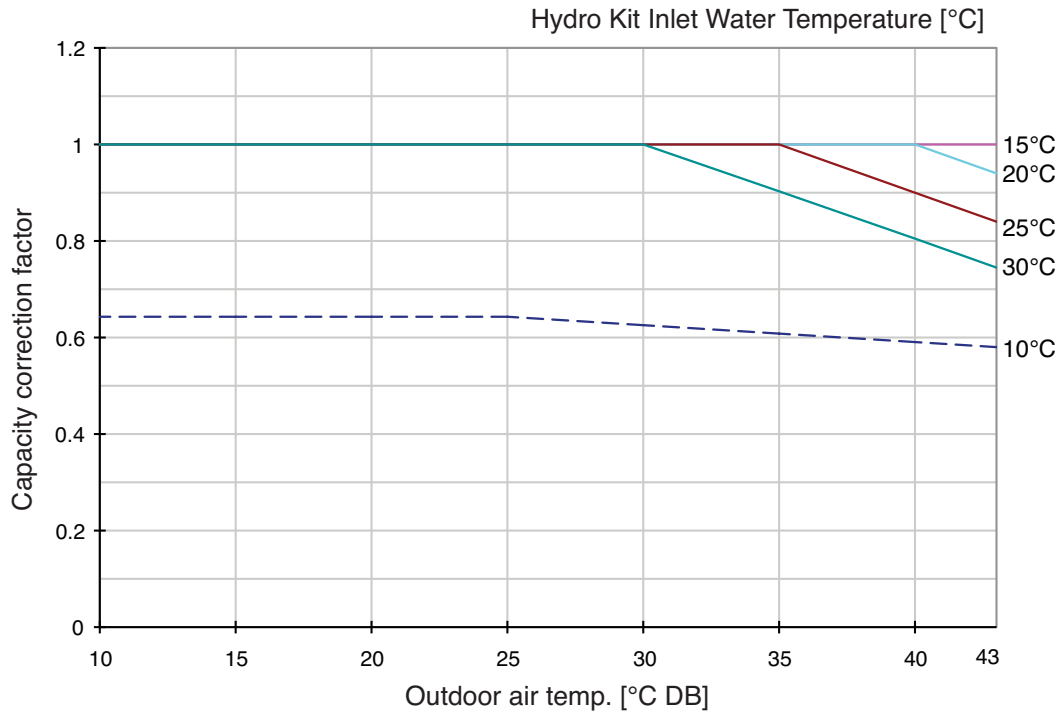

6. Capacity correction factor

6.1.2 ARNH10GK2A2 (Heating)

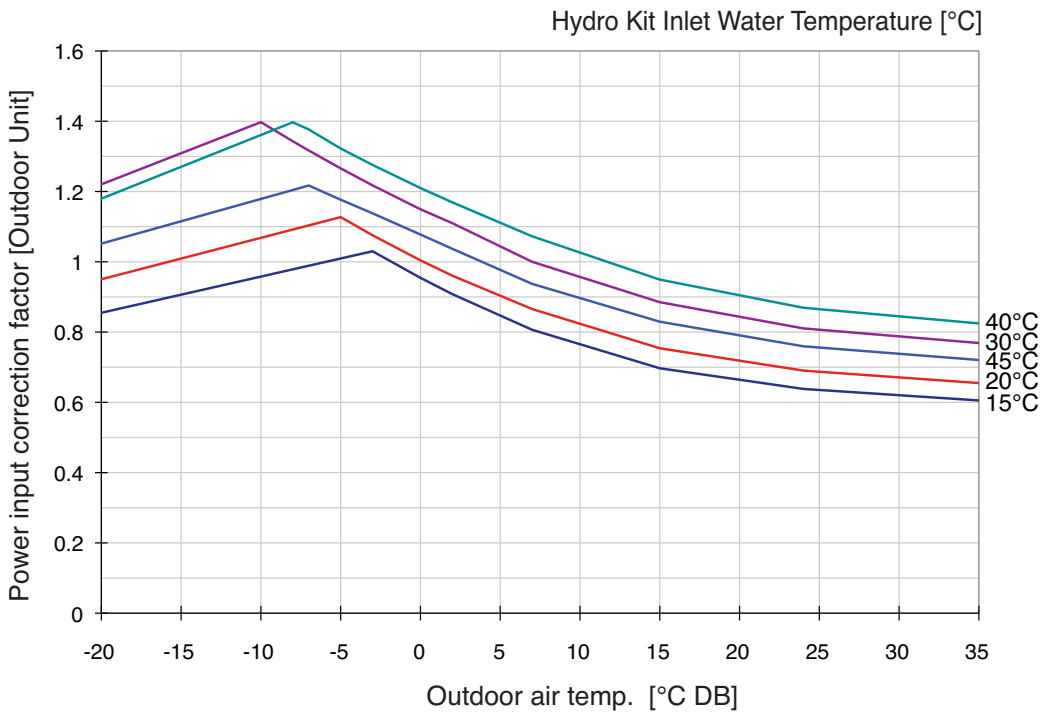
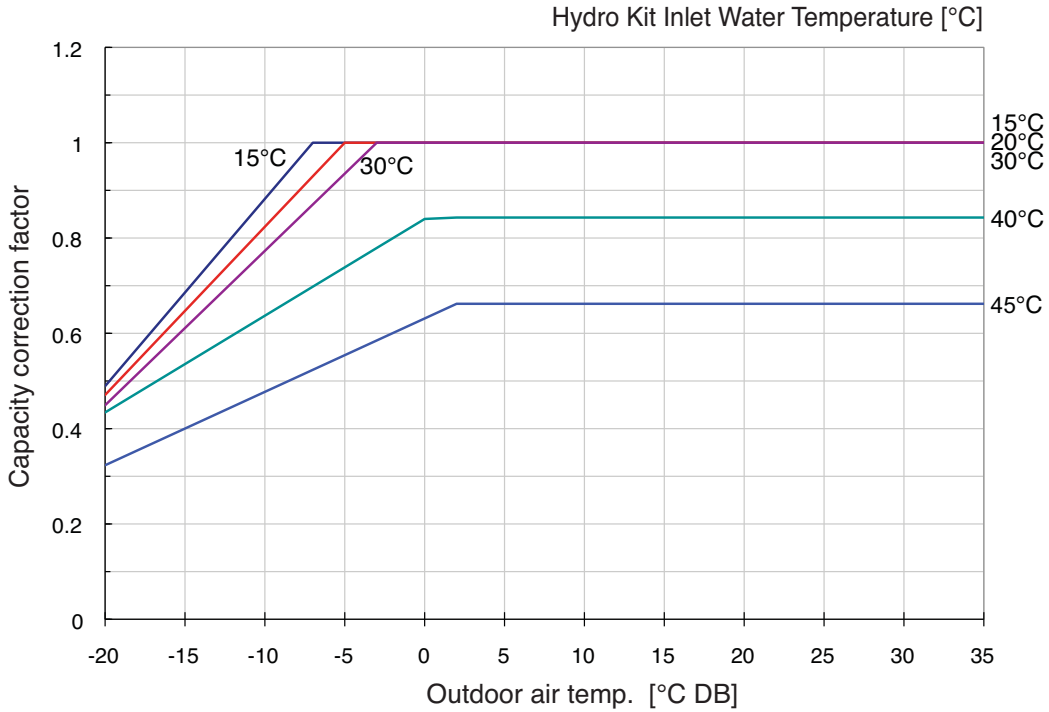

6. Capacity correction factor

6.2 Capacity correction factor by water flow rate

ARNH10GK2A2 (Cooling)

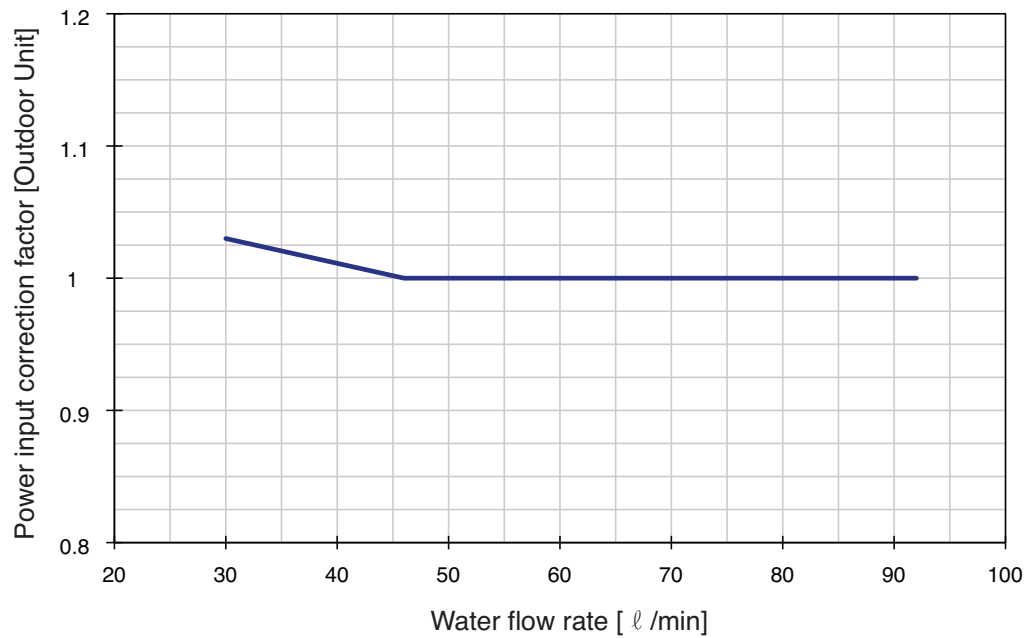
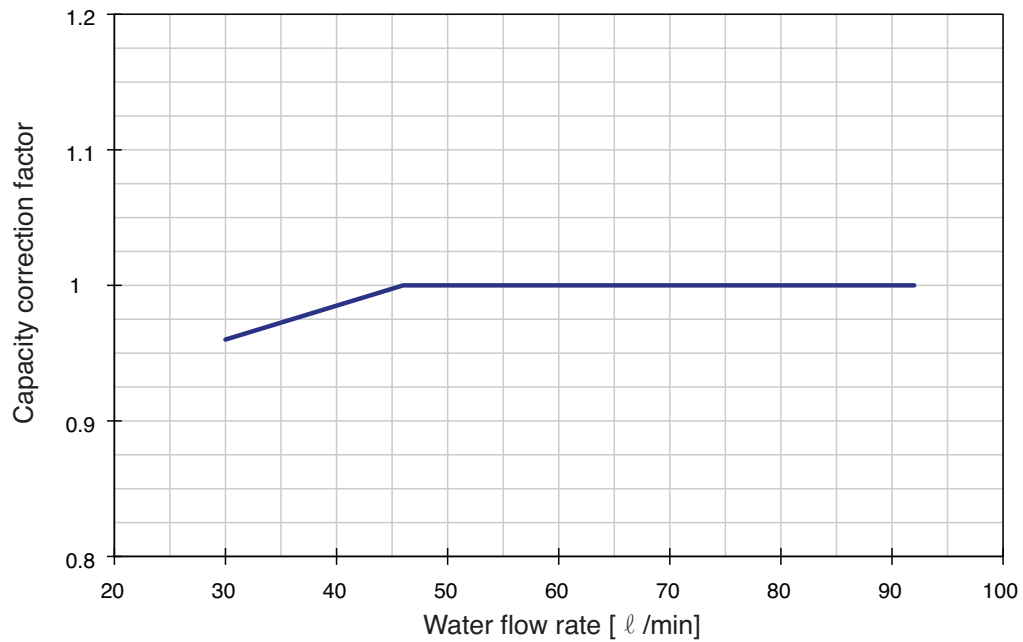

6. Capacity correction factor

ARNH10GK2A2 (Heating)

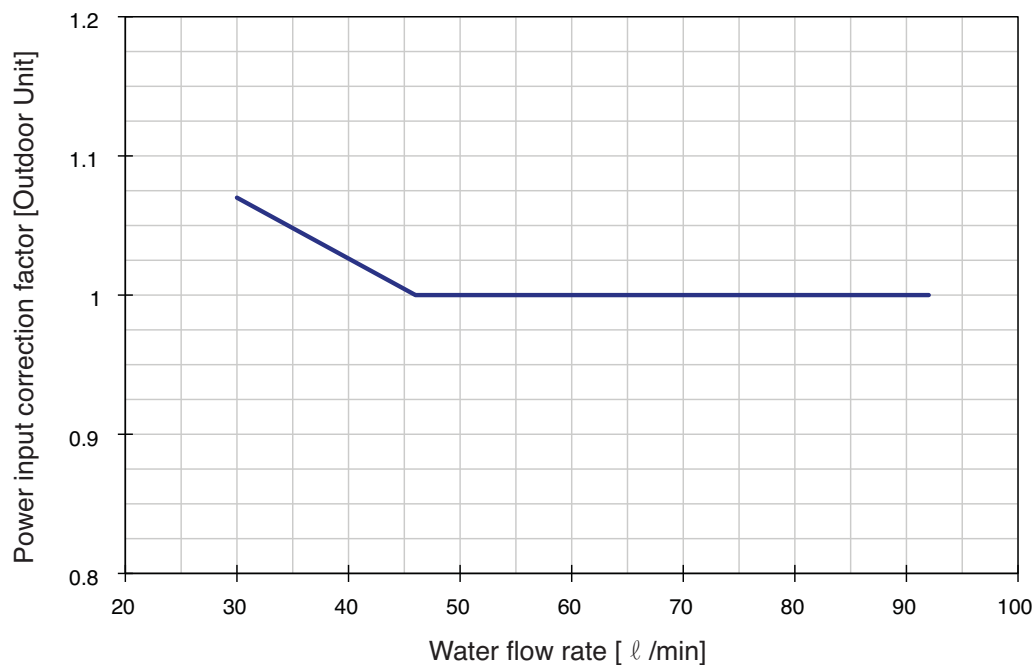
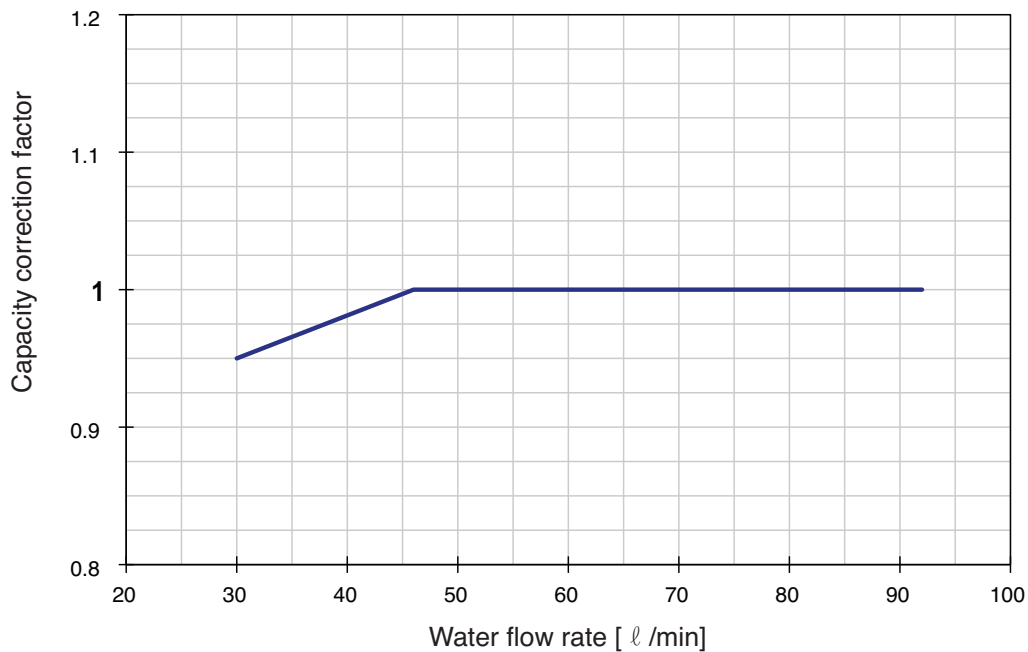

6. Capacity correction factor

6.3 Capacity correction factor by combination ratio

ARNH10GK2A2

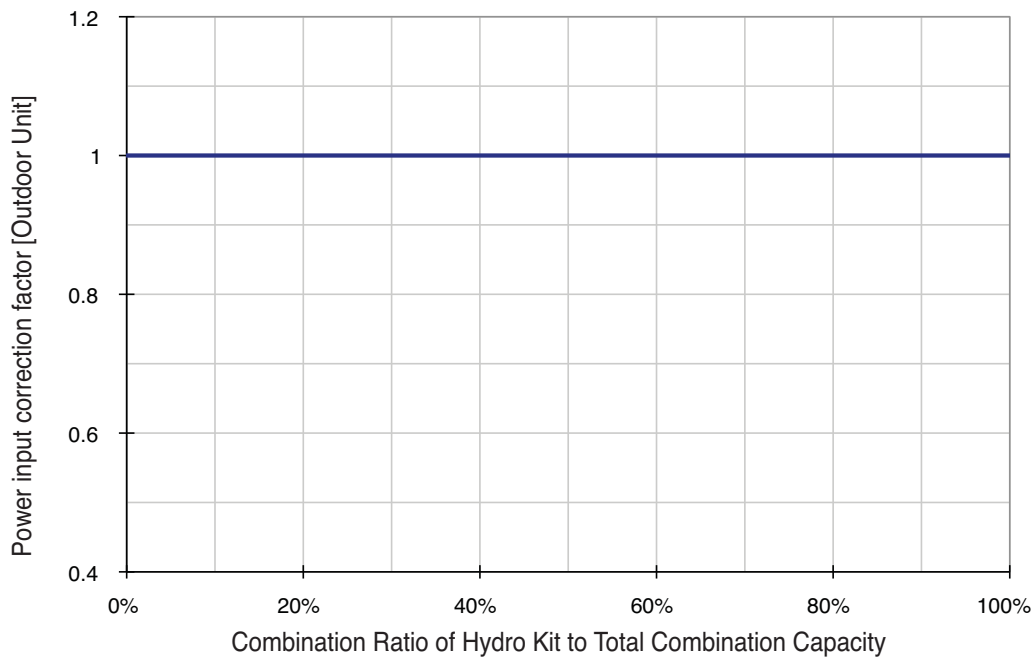
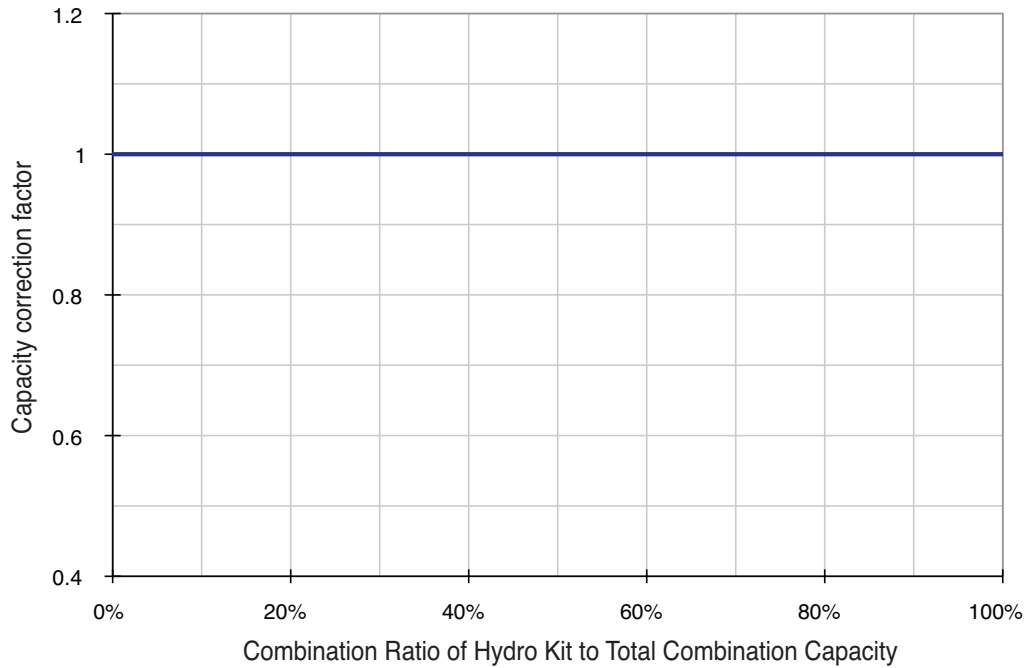

6. Capacity correction factor

6.5 Capacity correction factor by defrosting operation

The capacity table does not consider reduction in capacity when frost has accumulated or during defrosting. The capacity values considered these factors, in other words the integrated heating capacity values, can be obtained as follows:

Formula

Integrated Heating capacity = A

Value given in table of capacity characteristics = B

Integrated correction factor for frost accumulation = C

$A=B \times C$

Correction factor for finding integrated Heating capacity

Inlet Port Temperature of Heat Exchange (*C/RH 85%)	-7	-5	-3	0	3	5	7
Integrated Correction Factor for Frost Accumulation (Normal Defrost Operation)	0.98	0.95	0.93	0.86	0.93	0.96	1.0
Integrated Correction Factor for Frost Accumulation (Partial Defrost Operation)	0.98	0.95	0.93	0.91	0.95	0.97	1.0

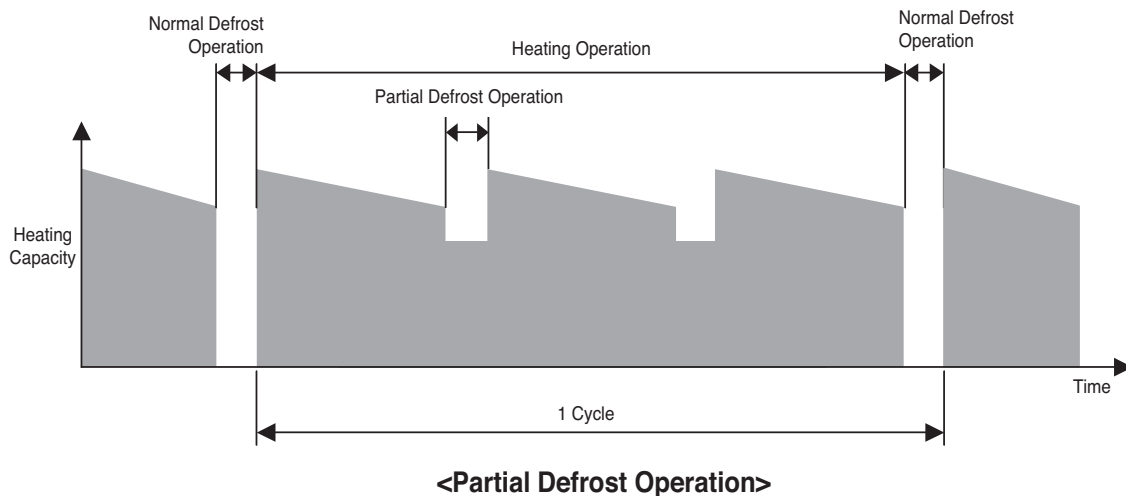
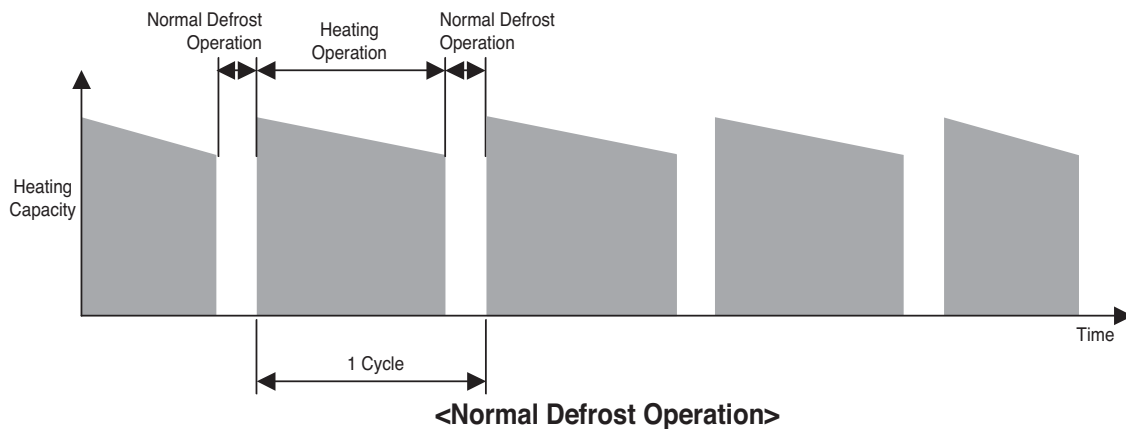

Please note that there will be temporary reduction in capacity when snow piles up on the outside surface of the outdoor unit heat exchanger. Of course, it will be different in degree depending on a number of other factors, for example, the outdoor temperature(°CDB), the relative humidity(RH) and the frosting amount.

6. Capacity correction factor

6.6 Capacity correction factor by antifreeze

Antifreeze Type	Item	Antifreeze % by wt				
		10%	20%	30%	40%	50%
Methanol	Cooling	0.998	0.997	0.995	0.993	0.992
	Heating	0.995	0.990	0.985	0.979	0.974
	Pressure Drop	1.023	1.057	1.091	1.122	1.160
Ethylene glycol	Cooling	0.996	0.991	0.987	0.983	0.979
	Heating	0.993	0.985	0.977	0.969	0.961
	Pressure Drop	1.024	1.068	1.124	1.188	1.263
Propylene glycol	Cooling	0.993	0.987	0.980	0.974	0.968
	Heating	0.966	0.973	0.960	0.948	0.935
	Pressure Drop	1.040	1.098	1.174	1.273	1.405

Correction factor of cooling capacity

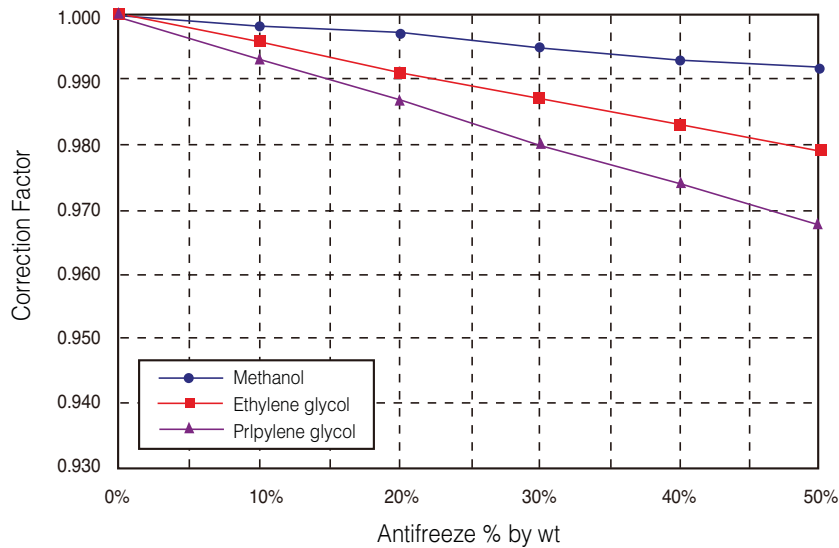

Correction factor of heating capacity

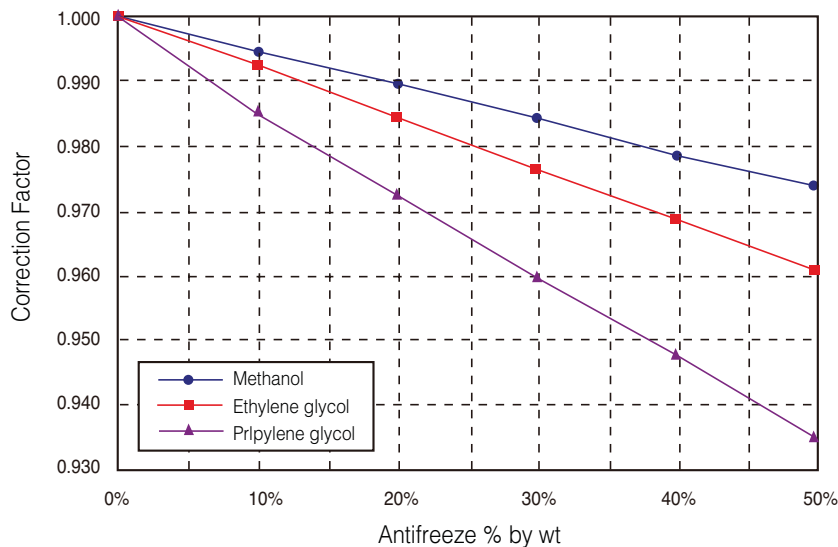

7. Water Pressure Drop

ARNH10GK2A2

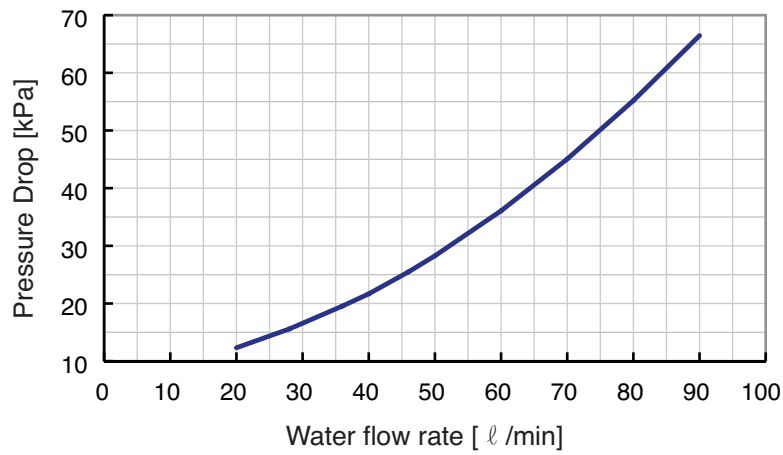

8. Operation Limits

8.1 ARNH10GK2A2 (Cooling)

Hydro Kit (Medium Temp.)

ARUN-series, ARUB-series

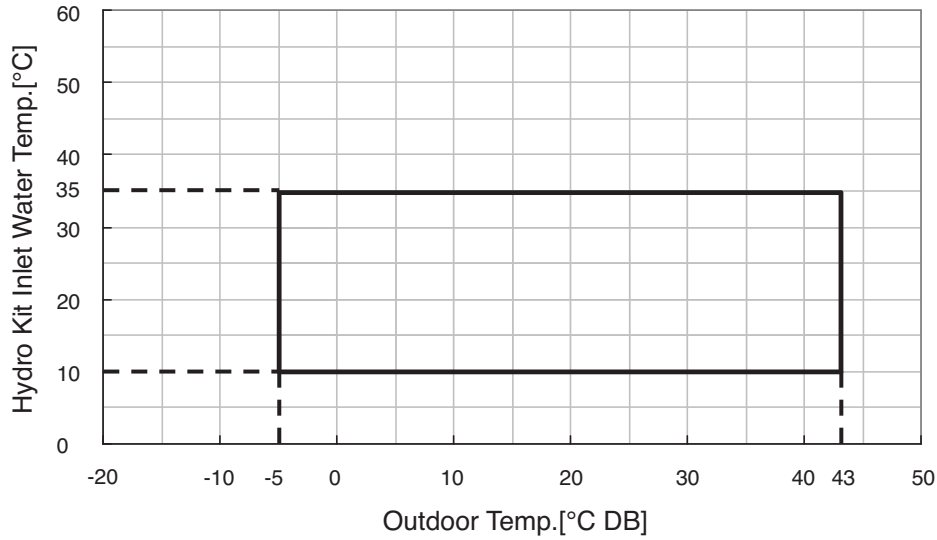

ARWN-series, ARWB-series

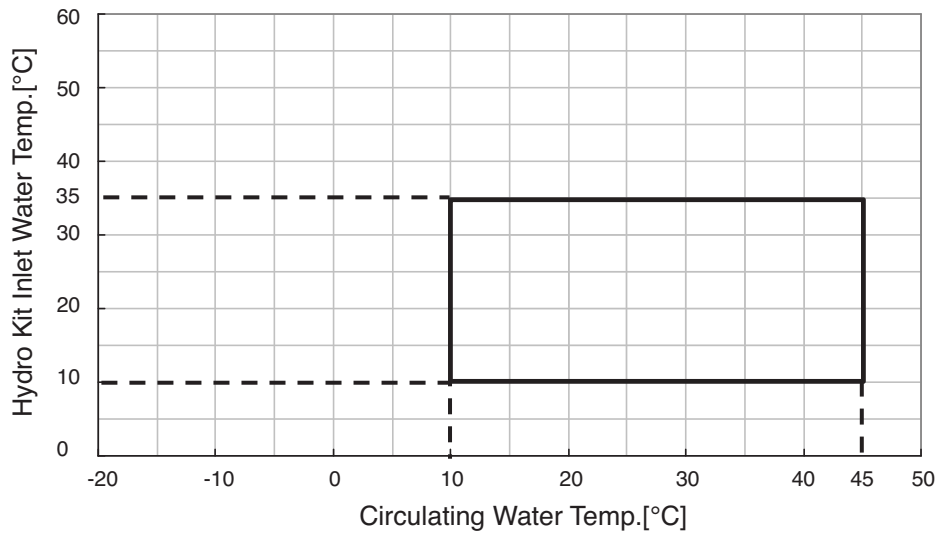

8. Operation Limits

8.2 ARNH10GK2A2 (Heating)

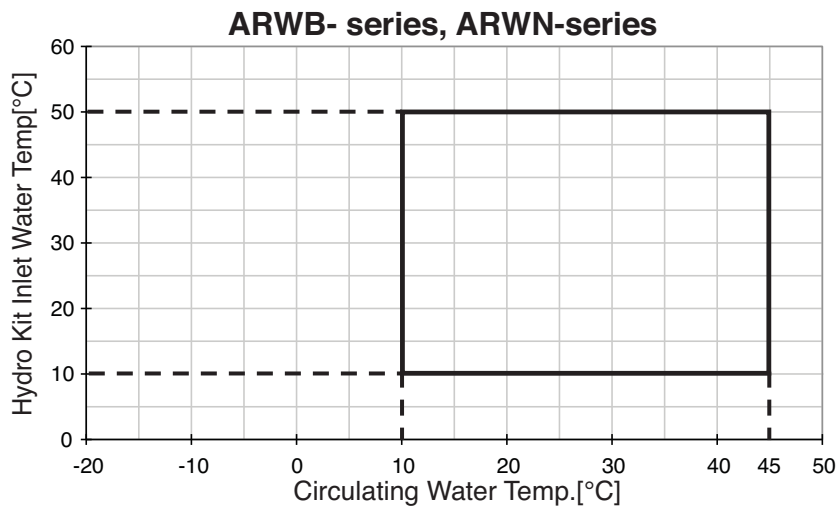
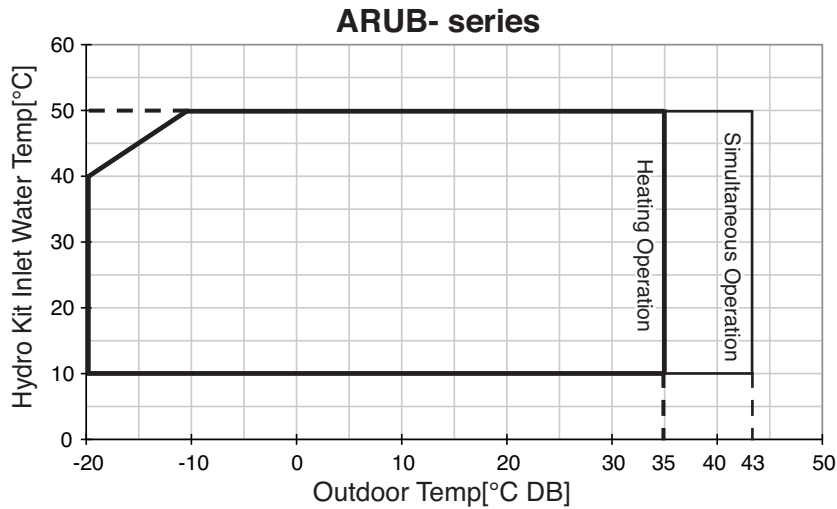
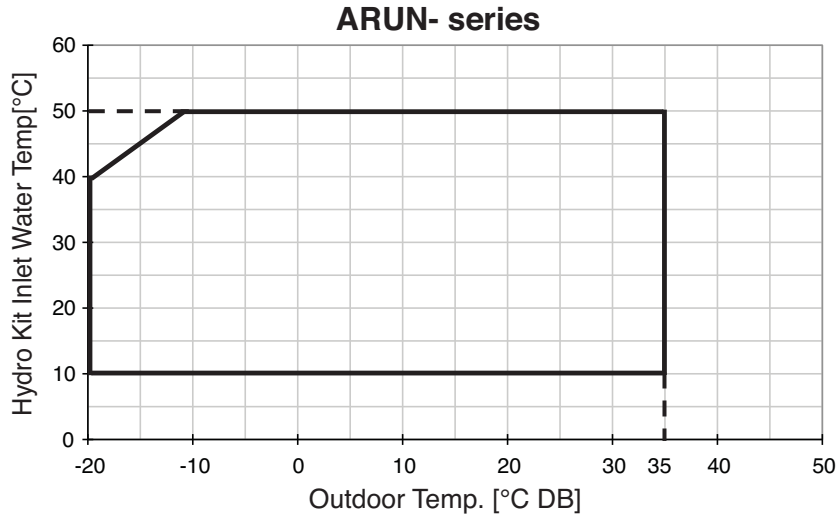

Notes

‘Simultaneous Operation’ means other Indoor units are operating on cooling mode.

9. Electric Characteristics

Wiring of Main Power Supply and Equipment Capacity

1. Separate power supply lines for the indoor units from outdoor unit..
2. Bear in mind ambient conditions (ambient temperature,direct sunlight, rain water,etc.) when proceeding with the wiring and connections.
3. The wire size is the minimum value for metal conduit wiring. The power cord size should be 1 rank thicker taking into account the line voltage drops. Make sure the power-supply voltage does not drop more than 10%.
4. Specific wiring requirements should adhere to the wiring regulations of the region.
5. Power supply cords of parts of appliances for outdoor use should not be lighter than polychloroprene sheathed flexible cord.
6. Don't install an individual switch or electrical outlet to disconnect each of indoor unit separately from the power supply.

CAUTION

- Follow ordinance of your governmental organization for technical standard related to electrical equipment, wiring regulations and guidance of each electric power company.
- Make sure to use specified wires for connections so that no external force is imparted to terminal connections. If connections are not fixed firmly, it may cause heating or fire.
- Make sure to use the appropriate type of overcurrent protection switch. Note that generated overcurrent may include some amount of direct current.

CAUTION

- Some installation site may require attachment of an earth leakage breaker. If no earth leakage breaker is installed, it may cause an electric shock.
- Do not use anything other than breaker and fuse with correct capacity. Using fuse and wire or copper wire with too large capacity may cause a malfunction of unit or fire.

ARNH10GK2A2

Model	Type	Hz	Volts	Voltage Range	Power Supply			Input(W)	
					MCA(A)	MFA(A)	FLA(A)	Cooling(W)	Heating(W)
ARNH10GK2A2	K2	50	220-240	Max:264 Min:198	0.06	15	0.05	10	10
	K2	60	220	Max:242 Min:198	0.06	15	0.05	10	10

Symbols:

MCA : Minimum Circuit Amperes (A)
MFA : Maximum Fuse Amperes(see note 5)
W : Rated Output
FLA : Full Load Amperes(A)

Note :

1. Voltage Range
Units are suitable for use on electrical system where voltage supplied to unit terminals is not below or above the listed range limits.
2. Maximum allowable voltage unbalance between phase is 2%.
3. MCA/MFA
 $MCA = 1.25 \times FLA$
 $MFA \leq 4 \times FLA$
(Next lower standard fuse rating. Minimum 15A)
4. Select wire size based on the MCA.
5. Instead of fuse, use Circuit Breaker.

10. Sound Levels

ARNH10GK2A2

Overall

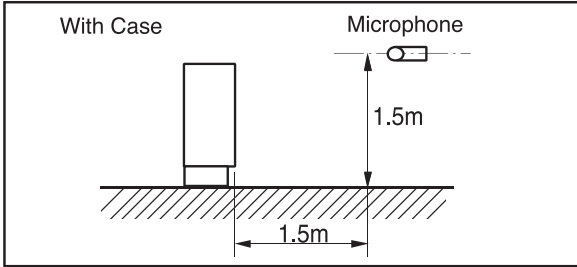

Notes:

- Sound measured at 1.5m away from the center of the unit.
- Data is valid at free field condition
- Data is valid at nominal operating condition
- Reference acoustic pressure 0dB = 20μPa
- Sound level will vary depending on a range of factors such as the construction(acoustic absorption coefficient) of particular room in which the equipment is installed.

Model	Sound Level (dB(A))
ARNH10GK2A2	26

Sound Pressure Level

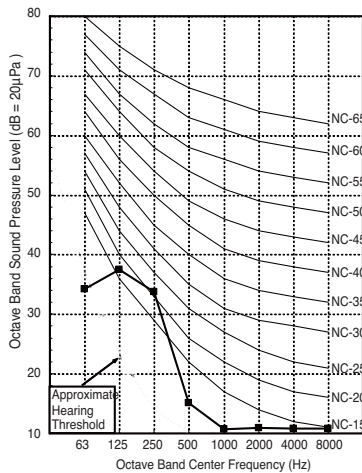

11. Installation

11.1 Selection of the best location

Select space for installing the unit, which will meet the following conditions:

- The place where the unit shall be installed inside.
- The place shall easily bear a load exceeding four times of the unit weight.
- The place where the unit shall be leveled.
- The place shall allow easy water drainage.
- The place where the unit shall be connected to the outdoor unit.
- The place where the unit is not affected by an electrical noise.
- The place where there should not be any heat source or steam near the unit.

Installation Space

- The following values are the least space for installation.
If any service area is needed for service according to field circumstance, obtain enough service space.
- The unit of values is mm.

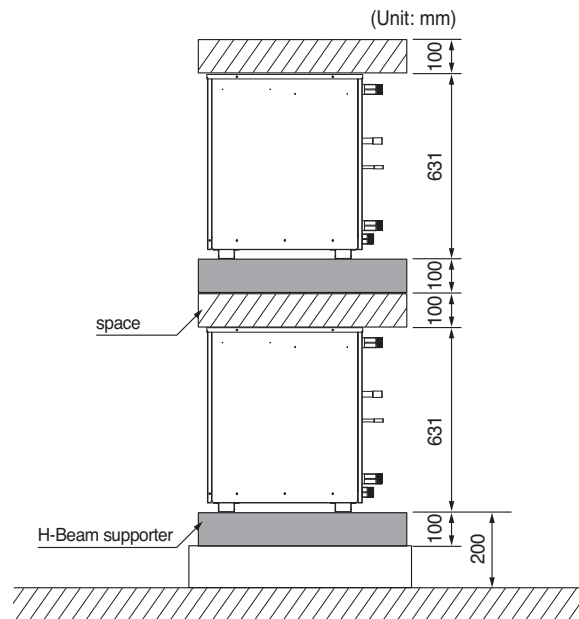
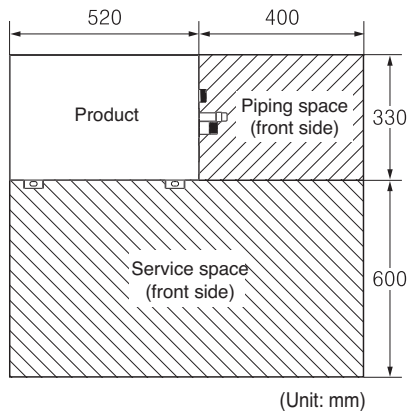

Foundation for Installation

- Fix the unit tightly with bolts as shown below so that the unit will not fall down due to earthquake.
- Noise and vibration may occur from the floor or wall since vibration is transferred through the installation part depending on installation status. Thus, use anti-vibration materials (cushion pad) fully (The base pad shall be more than 200 mm (7-7/8 inch)).

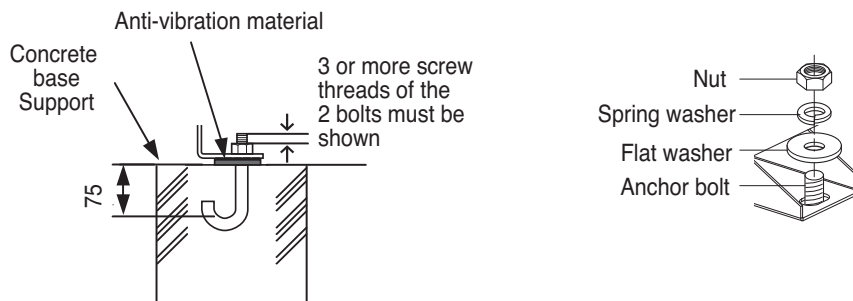

11. Installation

Drain pipe connection

- Hydro Kit does not use the drain pump.
- Do not install in upward direction.
- Install the drain pipe in downward direction (1/50-1/100).
- Hydro Kit drain connection pipe is PT 1.

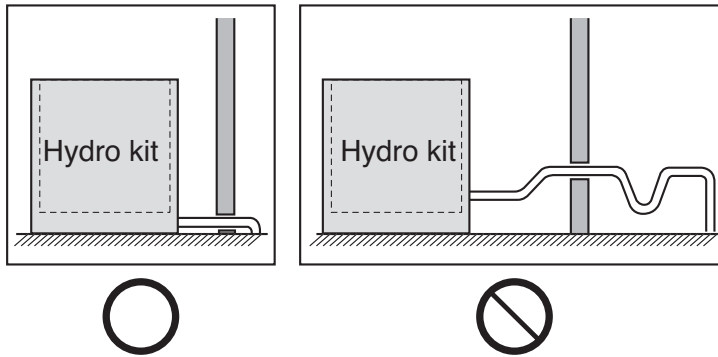

11.2 Water Piping and Water Circuit Connection

General Considerations

Followings should be considered before beginning water circuit connection.

- Service space should be secured.
- Water pipes and connections should be cleaned using water.
- Space for installing external water pump should be provided.
- Never connect electric power while proceeding water charging.

Water Piping and Water Circuit Connection

While installing water pipes, followings should be considered :

- While inserting or putting water pipes, close the end of the pipe with pipe cap to avoid dust entering.
- When cutting or welding the pipe, always be careful that inner section of the pipe should not be defective. For example, no weldments or no burrs are found inside the pipe.
- Pipe fittings (e.g. L-shape elbow, T-shape tee, diameter reducer, etc) should be tightened strongly to be free from water leakage.
- Connected sections should be leakage-proof treatment by applying tefron tape, rubber bushing, sealant solution, etc.
- Appropriate tools and tooling methods should be applied to prevent mechanical breakage of the connections.
- Operation time of flow valve(e.g. 3way valve or 2way valve) should be less than 90 seconds.
- Pipe is insulated to prevent heat loss to external environment.

11. Installation

11.2.1 Water cycle

* For the water pipe system, use the closed loop type.

1. For the parts of the water pipe system, use the parts above the design water pressure.
2. For the water pipe, do not use steel pipe.
3. For the drain pipe (1) size, use the same diameter as the product connected or larger.
 - Always install a natural drainage so that the drained water does not back flows.
4. To replace the connected device easily, install the union joint (2).
5. Install the service port (3) to clean the heat exchanger at each inlet and outlet of the water pipe.
6. Always install a strainer (4) at the inlet of the water pipe.
 - For the strainer, use one with 50 mesh or above with measurement diameter of 0.4mm or less. (Exclude other net)
 - Always install the strainer on the horizontal pipe.
(When dirt, trash, rusted pieces get into the water pipe system, it can cause problems to the product by corroding the metallic material.)
7. Install the air vent (5) at the top of the water pipe.
8. Install a thermometer (6) and pressure gauge (7) at the inlet and outlet of the water pipe.
9. Install the drain valve (8) that can be used for draining the water inside when replacing the part or providing service.
10. Install the shut-off valve (9) to block the water by closing the valve when replacing the part or cleaning.
11. Apply insulated treatment on the exterior of the water pipe so that water drops do not form.
12. Install excessive pressure safety valve (10) that meets the design water pressure to prevent unit or water pipe damage at the pressure increase inside the water pipe system.

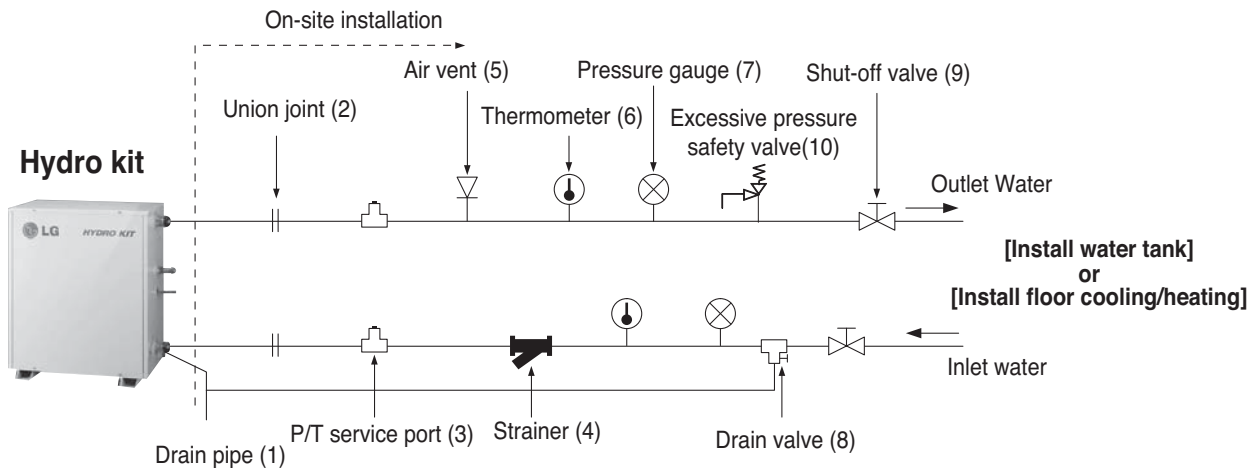

11. Installation

11.2.2 Water tank & Floor heating installation

1. Use the pump (1) with sufficient capacity to assure loss of overall water pressure and to supply water to the **Hydro Kit**.
2. Install the shut-off valve (2) on both sides of the pump to clean and repair the pump.
3. Install the flexible joint (3) to prevent noise and vibration transferred from the pump.
4. Install the pressure gauge (4) to monitor the water pressure from water tank. (Option)
5. Install the expansion tank (5) to accommodate the water contracted or expanded from the temperature difference and to supply the water.
6. After the installation of water pipe system is completed, open the water supply valve (6) and supply the water.
7. When installing the water tank, insert the water tank temperature sensor (7) to measure the temperature of the water inside the tank.
 - For the water tank temperature sensor, use the sensor supplied on the product.
 - When heating the floor, measure the temperature by using the remote controller or remote temperature sensor (Separately sold).
8. Use the water tank (9) with the heat exchange coil (8) installed so that the heat can be exchanged sufficiently inside the tank.

* Installation of water tank

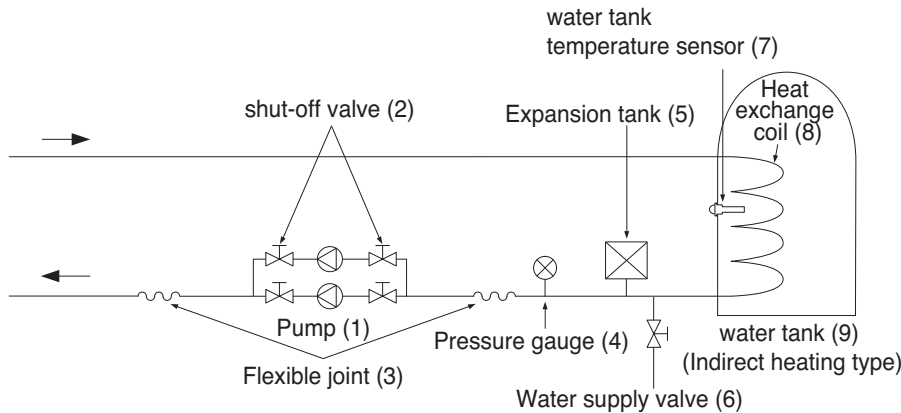

* Installation of floor heating

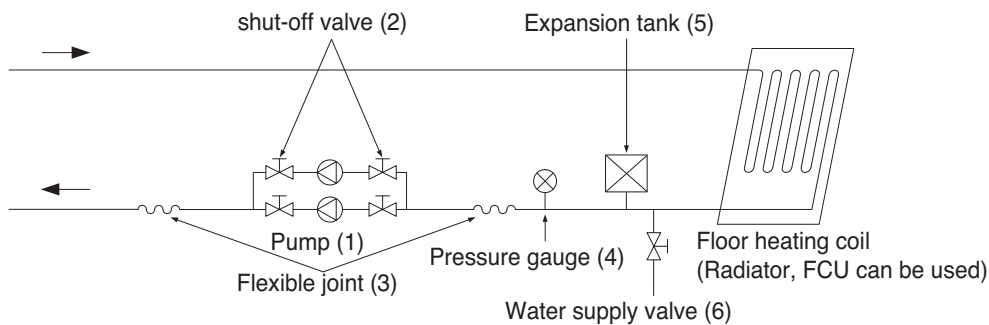

CAUTION:

- Water flow rate should be kept over 30LPM when Hydro Kit is operating.

11. Installation

11.2.3 Strainer

- Use the 50 mesh strainer.
(Exclude scale diameter of 0.4mm or less and other net)
- Check the strainer direction and assemble on the inlet hole (Refer to picture)
- Wrap the Teflon tape on the screw thread of the water pipe for more than 15 times for assembly.
- Install the service port facing downward. (Within left/right 45 degrees)
- Check if there is any leakage on the connecting part.
- Clean the strainer periodically. (Once a year or more frequent)

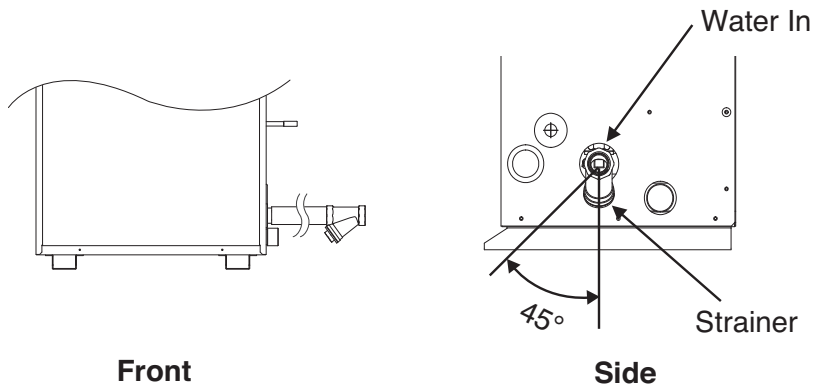

11. Installation

11.3 Sanitary Water Tank and Sanitary Water Tank Kit

11.3.1 Installation Condition

Installing sanitary water tank requires following considerations :

- Sanitary water tank should be located at the flat place.
- Water quality should comply with EN 98/83 EC Directives.
- As this water tank is sanitary water tank (indirect heat exchange), do not use anti water-freezing treatment like ethylene glycol.
- It is highly recommend to wash out inside of the sanitary water tank after installation. It ensures generating clean hot water.
- Near the sanitary water tank, there should be water supply and water drain for easy access and maintenance.

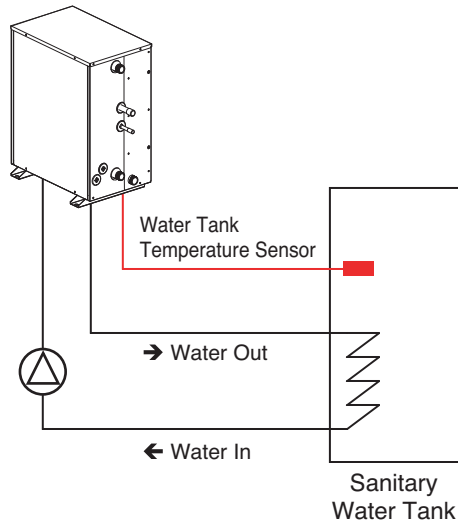

11.3.2 Water tank temperature sensor connection

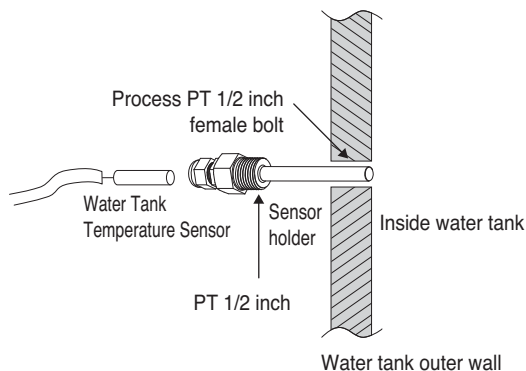

- If hot water mode is used, make sure to install sensor to water tank.
- Make PT15A female bolt hole in the water tank, and install sensor in the water tank.
- Push the sensor into the hole of the sensor holder cap.
- Lock the sensor holder cap.

11. Installation

WARNING :

Installing recirculation pump

When Hydro Kit is used with the sanitary water tank, it is **STRONGLY** recommended to install recirculation pump to prevent cold water at the end of hot water supply flooding out and to stabilize the water temperature inside the sanitary water tank.

- The recirculation pump should be operated when sanitary water demand is not required. Therefore, external time scheduler to determine when the recirculation pump should turn on and turn off is required.

- The operating duration time of the recirculation pump is calculated as follow :

$$\text{Duration time [minute]} = k * V / R$$

k : 1.2 ~ 1.5 is recommended.

(If distance between pump and tank is far, then choose high number.)

V : Volume of sanitary water tank [liter]

R : Water flow rate of pump [liter per minute], which is determined by pump performance curve.

- The pump operating start time should be prior to the sanitary water demand.

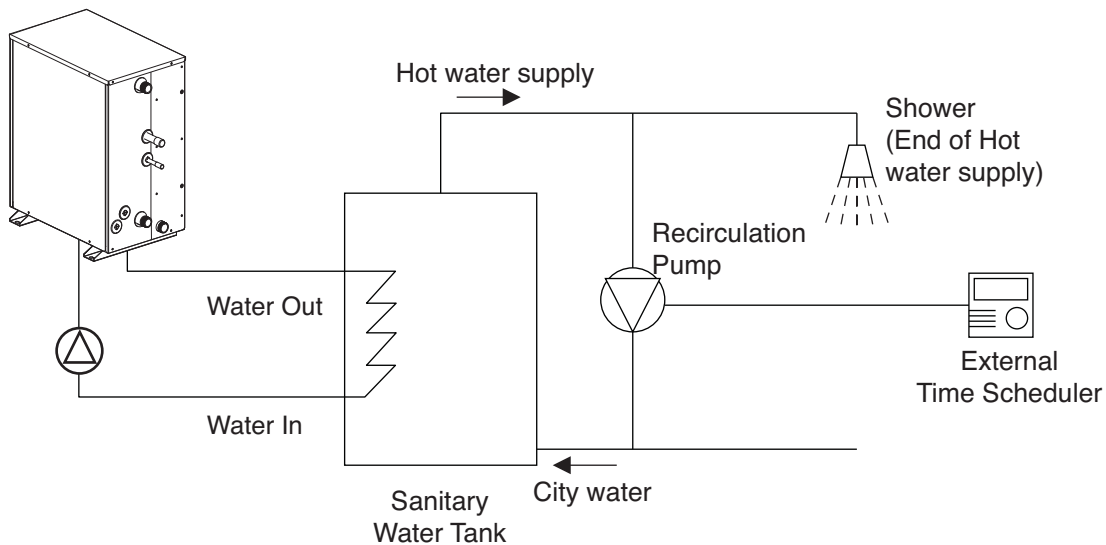

11. Installation

11.3.3 How to design the heat exchange coil inside water tank (Example)

*** General water heat exchange coil calculation**

$$Q = U \times A [t_s - (t_2 + t_1 / 2)]$$

Q: Heat exchange amount (kcal/hr)

U: Overall heat transfer coefficient (kcal/m²hr°C)

A: Heating area (m²)

T₁: Inlet temperature of heat source water (°C)

T₂: Outlet temperature of heat source water (°C)

T_s: Water temperature inside water tank
(Target temperature) (°C)

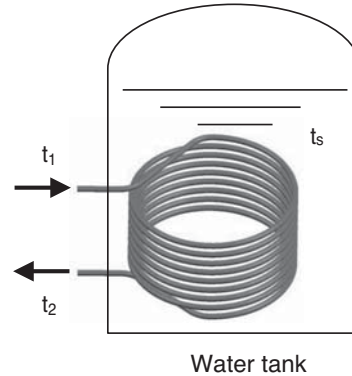

[Example] 32kW (=27520kcal/hr) heat exchanger calculation

If outer diameter of coil is 22mm

Coil length = $A / (3.14 \times 0.022)$

= About 32m

Design the clearance between coils at 20mm
or above to secure heat exchange area

16 rotations by designing the diameter to 650mm

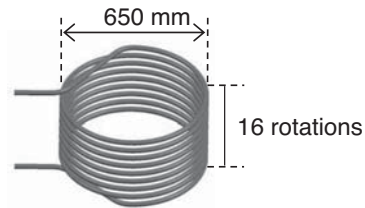

[Example] 32kW heat
exchanger coil
(For outer coil diameter
of 22mm)



CAUTION:

- Design of the heat exchange coil inside the water tank can differ by the shape and condition of the water tank.

11. Installation

11.4 Solar Thermal Kit

How to Install Solar Thermal Kit

- Step 1.** Check the diameter of pre-installed pipes. (symbol Ⓐ and Ⓑ)
- Step 2.** If the diameter of pre-installed pipes is different from diameter of solar thermal kit, it is necessary to reduce or extend of pipe's diameter.
- Step 3.** After Step 2., connect the pipe and solar thermal kit.
- Step 4.** Connect solar thermal sensor to 'CN_TH4'(Red connector) of the indoor unit PCB.
If the sanitary tank sensor is connected, disconnect the sensor from PCB first.

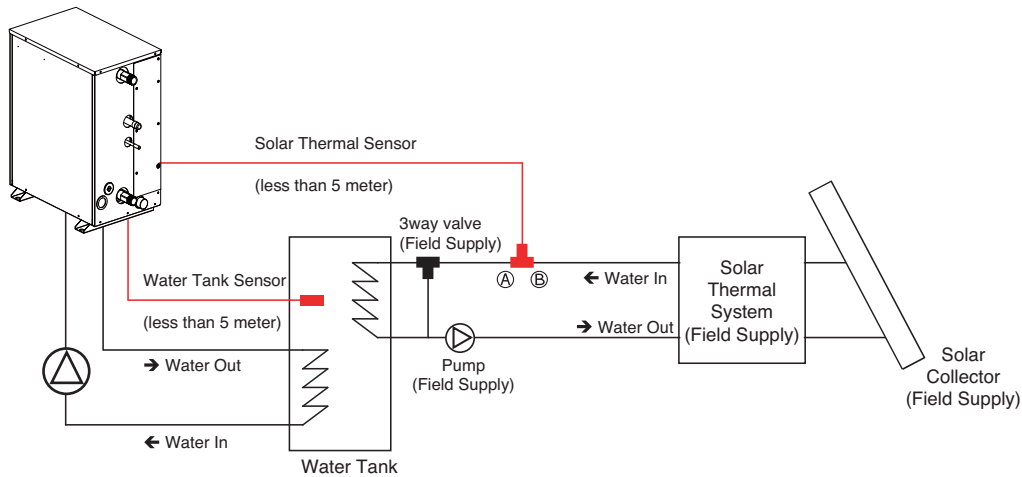

11. Installation

11.5 Installation Scenes

Some installation scenes are presented for example. As these scenes are conceptual figures, installer should optimize the installation scene according to the installation conditions.

1) Floor Heating only

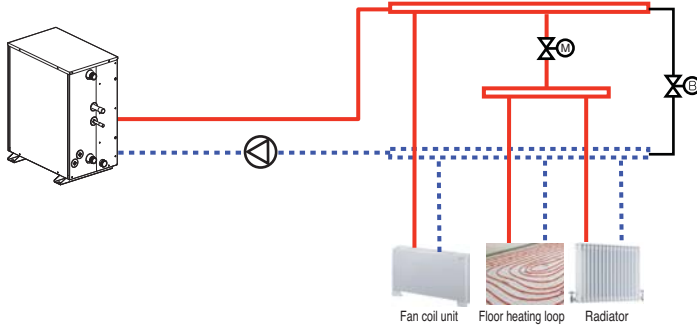

2) Floor Heating + Hot water

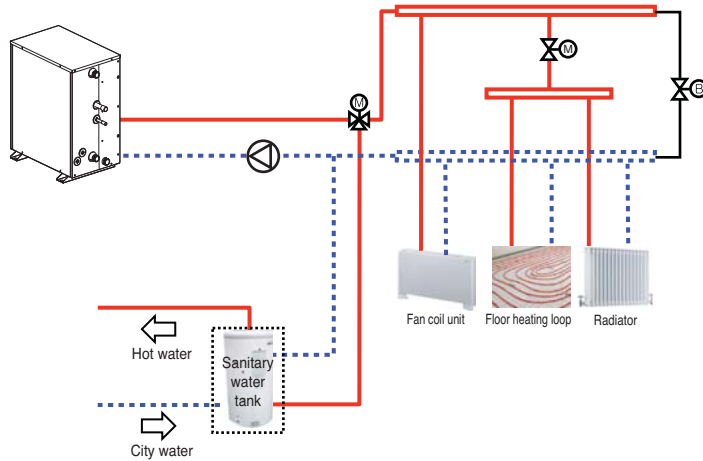

3) Floor Heating + Hot Water + Solar Thermal

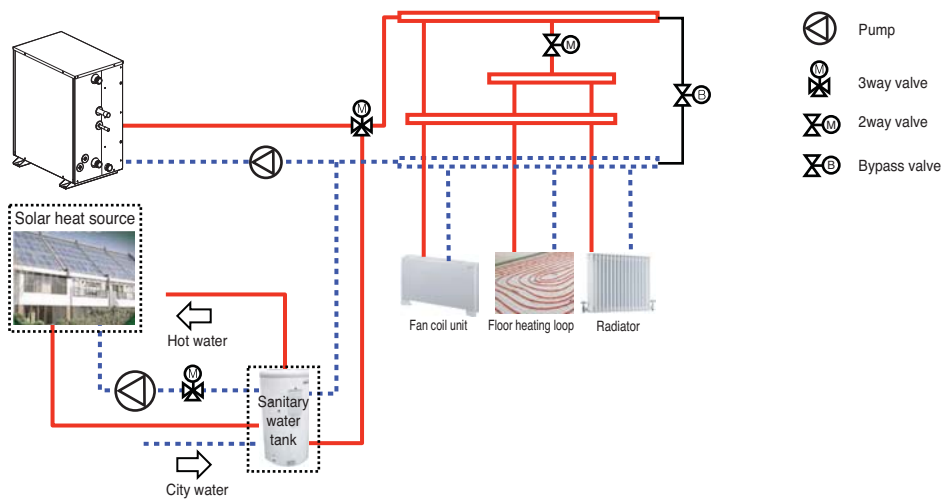

-  Pump
-  3way valve
-  2way valve
-  Bypass valve

11.6 Water Quality

Water quality should comply with EN 98/83 EC Directives. Requirement for resolved chemical ingredients is following table. Detailed water quality condition can be found in EN 98/83 EC Directives.

Parameter	Value	Parameter	Value
Acrylamide	0.10 $\mu\text{g/l}$	Fluoride	1.5 mg/l
Antimony	5.0 $\mu\text{g/l}$	Lead	10 $\mu\text{g/l}$
Arsenic	10 $\mu\text{g/l}$	Mercury	1.0 $\mu\text{g/l}$
Benzene	1.0 $\mu\text{g/l}$	Nickel	20 $\mu\text{g/l}$
Benzo(a)pyrene	0.010 $\mu\text{g/l}$	Nitrate	50 mg/l
Boron	1.0 mg/l	Nitrite	0.50 mg/l
Bromate	10 $\mu\text{g/l}$	Pesticides	0.10 $\mu\text{g/l}$
Cadmium	5.0 $\mu\text{g/l}$	Pesticides — Total	0.50 $\mu\text{g/l}$
Chromium	50 $\mu\text{g/l}$	Polycyclic aromatic hydrocarbons	0.10 $\mu\text{g/l}$
Copper	2.0 mg/l	Selenium	10 $\mu\text{g/l}$
Cyanide	50 $\mu\text{g/l}$	Tetrachloroethene and Trichloroethene	10 $\mu\text{g/l}$
1,2-dichloroethane	3.0 $\mu\text{g/l}$	Trihalomethanes — Total	100 $\mu\text{g/l}$
Epichlorohydrin	0.10 $\mu\text{g/l}$	Vinyl chloride	0.50 $\mu\text{g/l}$

CAUTION:

- If the unit is installed at existing hydraulic water loop, it is important to clean hydraulic pipes to remove sludge and scale.
- Installing sludge strainer in the water loop is very important to prevent performance degrade.
- Chemical treatment to prevent rust should be performed by installer.

Frost protection

In areas of the country where entering water temperatures drop below 15°C(59°F), the water pipe must be protected by using an approved antifreeze solution. Consult your **Hydro Kit** unit supplier for locally approved solutions in your area. Calculate the approximate volume of water in the system. (Except the **Hydro Kit** unit.) And add antifreeze solution to the total volume to allow for the water contained in **Hydro Kit** unit.

Type of Antifreeze	Minimum Temperature for Freeze Protection				
	15°C(59°F) ~ -5°C(23°F)	-10°C(14°F)	-15°C(5°F)	-20°C(-4°F)	-25°C(-13°F)
Ethylene glycol	12%	20%	30%	-	-
Propylene glycol	17%	25%	33%	-	-
Methanol	6%	12%	16%	24%	30%

CAUTION:

1. Use only one of the above antifreeze.
2. If a antifreeze is used, pressure drop and capability degradation of the system can occur.
3. If one of antifreezes is used, corrosion can occur. So please add corrosion inhibitor.
4. Please check the concentration of the antifreeze periodically to keep same concentration.
5. When the antifreeze is used (for installation or operation), take care to ensure that antifreeze must not be touched.
6. Ensure to respect all laws and norms of your country about Anti-freeze usage.
7. When hydro kit is applied for cooling, the antifreeze must be added in the water circuit to prevent freezing.

11. Installation

11.7 Refrigerant Piping

Cut the pipes and the cable

- Use the accessory piping kit or the pipes purchased locally.
- Measure the distance between the indoor and the outdoor unit.
- Cut the pipes a little longer than measured distance.
- Cut the cable 1.5m longer than the pipe length.

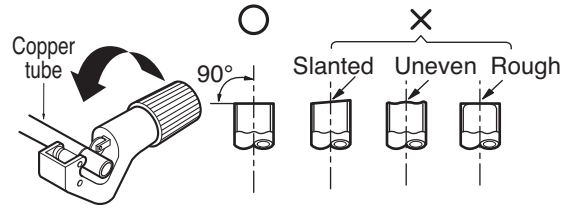

Burrs removal

- Completely remove all burrs from the cut cross section of pipe/tube.
- Put the end of the copper tube/pipe to downward direction as you remove burrs in order to avoid to let burrs drop in the tubing.

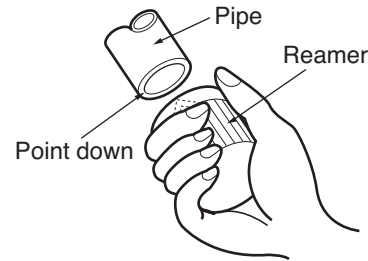

Pipe welding

- Insert and weld the pipe.
- Always make sure to flow Nitrogen at 0.2kgf/cm² within the pipe when welding.
- If the welding is done without flowing Nitrogen, it can generate a thick oxidized coating within the pipe to interfere with normal operation of valve and compressor etc.

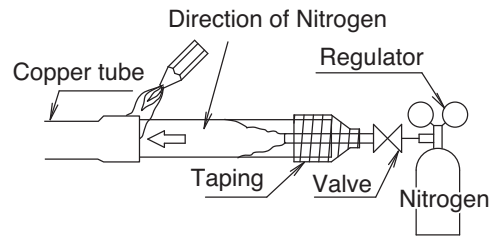

Insulation

- Use rubber foamed insulation material (EPDM, NBR) with high thermal resistance.
- When installed in humid environment, use thicker insulation material than usual.
- Insert the insulation material within the product as deep as possible.

※ The thickness of the above insulation material is based on thermal conduction rate of 0.036W/m °C.

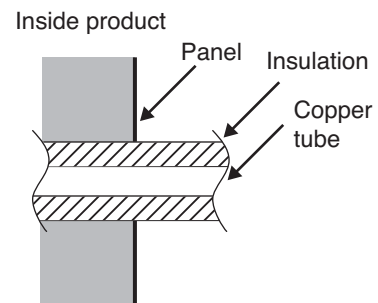

Classification	Thickness
Liquid pipe(Ø9.52)	t9 or above
Gas pipe(Ø22.2)	t19 or above

11. Installation

Precaution when connecting Heat Recovery systems

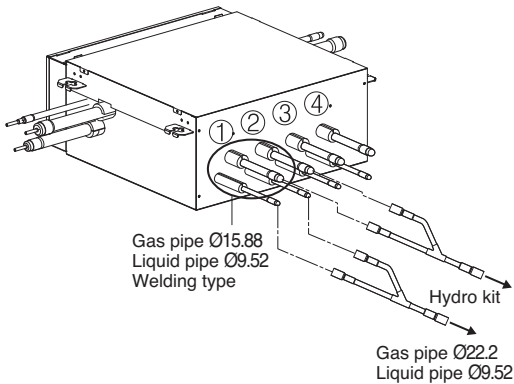

- One connection of refrigerant pipe for HR unit is insufficient for the flow of refrigerant. Join two pipes with a branch pipe when connecting the **Hydro Kit**.
- The pipe number of the connected gas pipe and liquid pipe must be same.
- Do not flow water in the **Hydro Kit** when pipe-searching process is performed.
- Pipe-searching process error may occur if the pipe temperature does not increase.
- It is recommended that **Hydro Kit** is connected to No.1 valve and No.2 valve.

Hydro Kit (Medium Temp.)

	DIP S/W setting	Example
Not control		
No.1, 2 Valve Control		
No.2, 3 Valve Control		
No.3, 4 Valve Control		
No.1, 2 Valve / No.3, 4 Valve Control		

Auto-Piping process

- When Auto-Piping process is performed,
 - Use 'Mode 1' if water temperature is higher than 30°C(86°F)
 - Use 'Mode 2' if water temperature is lower than 30°C(86°F)
- When Auto-Piping process is not performed,
 - Check whether 'CH14' error occurs in the **Hydro Kit**.

* Refer to the installation manual of HR unit

11. Installation

11.8 Electrical Wiring

11.8.1 How to connect wirings

Remove the box cover of electric parts and connect the wiring.

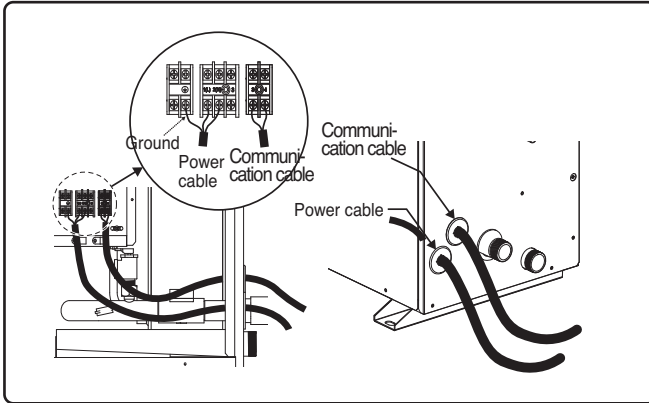

CAUTION:

When connecting the power and communication cable, always use the terminal connector (O-ring, Y-ring).

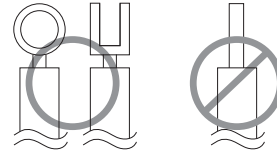

Make sure to tighten so that the screw of the terminal does not get loose.

Connect the wires to the terminals on the control board individually according to the outdoor unit connection.

- Ensure that the wire color of the outdoor unit and terminal No. are same as those of the indoor unit respectively.

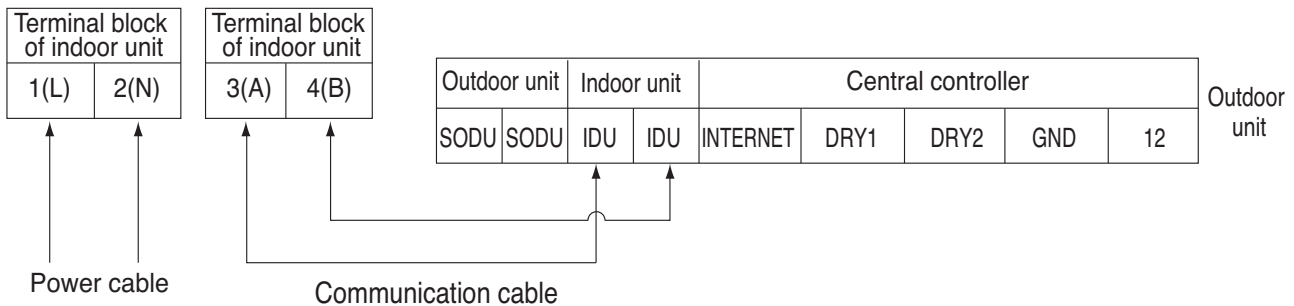

WARNING : Make sure that the screws of the terminal are free from looseness.



CAUTION:

After checking the above status, prepare for the following wiring :

- 1) Use individual power for the unit and refer to the circuit diagram posted on the inside of the control cover.
- 2) Make sure to install the circuit breaker when power is connected to the unit.
- 3) The bolts used for cable connection may become loose by the vibration generated during the transportation. Make sure to check again and fasten them tightly. (If they are loose, it may cause fire.)
- 4) Make sure to check power specification.
- 5) Electrical capacity shall be sufficient.
- 6) The initial voltage shall be maintained at 90% of the rated voltage on the name plate.
- 7) The thickness of the power cable complies with the designated specification. (length and thickness of the power cable)
- 8) Do not install the circuit breaker in the place where there is a lot of moisture or where it is wet.
- 9) The following problems may be the cause of voltage drop.
 - Magnetic switch vibration, defective contact, fuse damage, malfunction of overload protection device

* Based on the owner's manual, teach how to operate and use the unit to the user. (temperature setting, etc.)

11. Installation

11.8.2 Connecting Cables

Types of the cables

Classification	Types	Cable cross section
Power cable(CV)	mm ² x cores	2.5 x 3
Communication cable(VCTF-SB)	mm ² x cores	1.0~1.5 x 2

The distance between communication cable and power cable

- If the power cable and communication cable are tied together, system malfunction may occur with electrostatic, electromagnetic combination effect causing the interference signal. If communication cable is connected along with power cable, secure at least 50mm distance between indoor unit power cable and communication cable.

It is the value with the assumption of the length of the parallel cable as 100 m. If it is longer than 100m, it shall be calculated again with proportional to the added length.

If the distortion in the waveform of the power still occurs despite securing the distance, increase the distance.

※ When several power cables are inserted into the transmission line, or tied together, make sure to consider the following issues.

- Power cables and communication cable shall not be in the same transmission line.
- Power cables and communication cable shall not be tied together.



WARNING

- Are all of the indoor units and outdoor units grounded?
- If grounding is not properly done, there is a risk of electric shock. Grounding must be done by a qualified technician.
- Consider the surrounding conditions(surrounding temperature, direct sunlight, rain water, etc.) when wiring the cable.
- The thickness of the power cable is the minimum thickness of metal conductor cable. Use thicker cable considering the voltage drop.

12. Accessories Installation

12.1 Location of Accessories and External Parts Connection



Dry contact board attachment location

Water tank temperature sensor locking location (CN-TH4)

Dry contact board locking location (CN-CC)

Remote controller locking location (CN-REMO)

3WAY VALVE (B)			WATER PUMP (B)				3WAY VALVE (A)		
1 L	2 L1	3 N	4 L	5 N	6	7	8 L	9 L1	10 N
BR	WH	BL	BR	BL			BR	WH	BL

PUMP (A)			2WAY VALVE (A)			THERMOSTAT (Default : 230V AC)			
11	12	13	14	15	16	17	18	19	20
L	N		L1	L2	N	L	N	L1	L2
BR	BL		BR	WH	BL	BR	BL	WH	BK

- Connect 3way valve, if both floor heating and hot water is used.
- Connect the separately purchased thermostat.
- Dry contact is an accessory supplied by LG and installed by referring to the attached installation manual.
- 3way valve, thermostat and pump are external parts for installation, which are not supplied by LG. After checking each part carefully, install external parts respectively.
- Connect the cable of each accessory to the terminal block of the control box in the **Hydro Kit**.
- Check the label attached on the terminal block to prevent wrong connection.
- Use the pump of 220 voltage and maximum operation current of 4A or less.
- Select a suitable relay for pump capacity when connecting the pump to the unit.



WARNING:

- Install the unit after turning off the main power.
- Do not connect the products out of range specified in the manual.
- Do not work with wet hand.

12. Accessories Installation

12.2 Installation of Wired Remote Controller

1. Please fix tightly using provided screw after placing remote controller setup board on the place where you like to setup.

- Please set it up not to bend because poor setup could take place if setup board bends.
Please set up remote controller board fit to the reclamation box if there is a reclamation box.

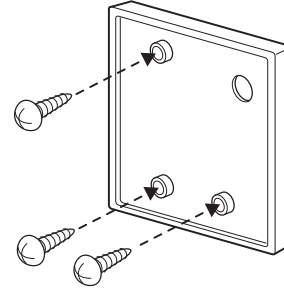

2. Can set up Wired remote controller cable into three directions.

- Setup direction: the surface of wall reclamation, upper, right
- If setting up remote controller cable into upper and right side, please set up after removing remote controller cable guide groove.

* Remove guide groove with long nose.

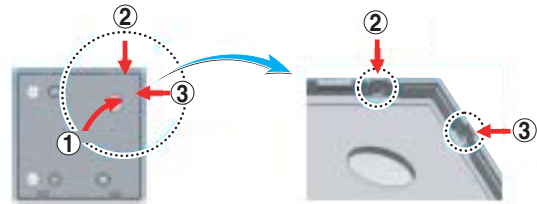

<Wire guide grooves>

- ① Reclamation to the surface of the wall
- ② Upper part guide groove
- ③ Right part guide groove

3. Please fix remote controller upper part into the setup board attached to the surface of the wall, as the picture below, and then, connect with setup board by pressing lower part.

- Please connect not to make a gap at the remote controller and setup board's upper and lower, right and left part.

When separating remote controller from setup board, as the picture below, after inserting into the lower separating hole using screw driver and then, spinning clockwise, remote controller is separated.

- There are two separating holes. Please individually separate one at a time.
- Please be careful not to damage the inside components when separating.

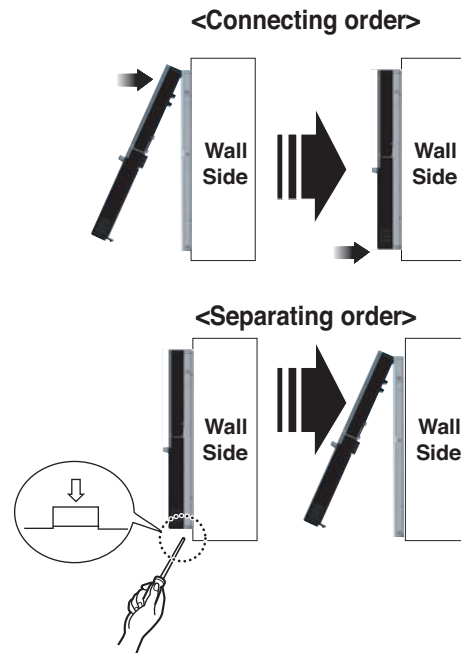

12. Accessories Installation

4. Please connect indoor unit and remote controller using connection cable.

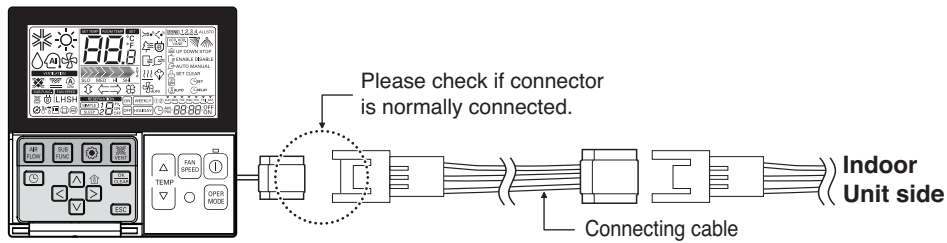

5. Please use extension cable if the distance between wired remote controller and indoor unit is more than 10m.

CAUTION

When installing the wired remote controller, do not bury it in the wall.

(It can cause damage in the temperature sensor.)

Do not install the cable to be 50m or above. (It can cause communication error.)

- When installing the extension cable, check the connecting direction of the connector of the remote controller side and the product side for correct installation.
- If you install the extension cable in the opposite direction, the connector will not be connected.
- Specification of extension cable: 2547 1007 22# 2 core 3 shield 5 or above.

12. Accessories Installation

12.3 Main Pump Connection

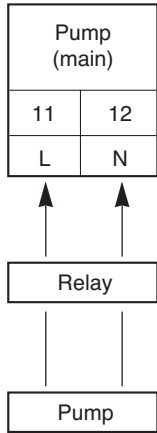

- Select the suitable pump by referring to the flow rate table with water temperature difference between the entrance and the exit.
- It is recommended that the flow rate is 46LPM.
- Use the pump with enough capacity to guarantee the loss of entire water pressure and to supply the **Hydro Kit** with water.
- Select a suitable relay for pump capacity when connecting the pump to the unit.
- Connect the relay to the terminal block 11 and 12 of the control box.



CAUTION:

- Make sure to supply external power with the pump.

12.4 Water tank temperature sensor Connection

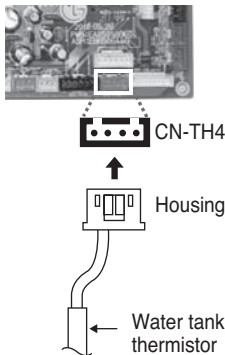

- Connect sensor housing to PCB 'CN-TH4' connector (red).



CAUTION:

- If water tank temperature sensor is not connected, error will occur. (CH08) Exclude the case of using floor heating.

12. Accessories Installation

12.5 Thermostat

Thermostat is generally used to control the unit by air temperature. When thermostat is connected to the unit, the unit operation is controlled by the thermostat.

12.5.1 Installation Condition



CAUTION:

1. USE 1~230 V Thermostat.
2. Some electro-mechanical type thermostat has internal delay time to protect compressor. In that case, mode change can takes time more than user's expectation. Please read thermostat manual carefully if the unit does not response quickly.
3. Setting temperature range by thermostat can be different with that of the unit. The heating set temperature should be chosen within the setting temperature range of the unit.
4. It is highly recommended that the thermostat should be installed where space heating is mainly applied.

Following location should be avoid to secure proper operation :

- Height from floor is approximately 1.5 m.
- Thermostat can not be located where the area may be hidden when door is open.
- Thermostat can not be located where external thermal influence may be applied. (such as above heating radiator or open window)

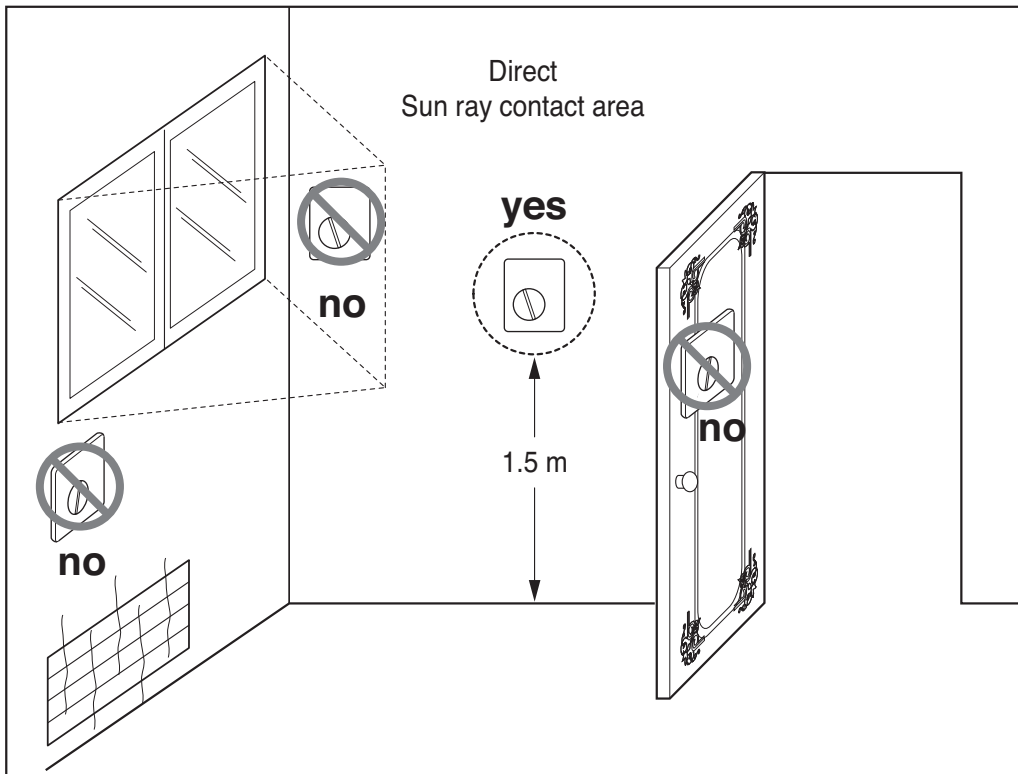

12. Accessories Installation

12.5.2 General Information

Hydro Kit supports following thermostats.

Type	Power	Operating Mode	Supported
Mechanical (1)	1~ 230 V	Heating Only (3)	Yes
		Heating / Cooling (4)	Yes
	1~ 24 V	Heating Only (3)	Yes
		Heating / Cooling (4)	Yes
Electrical (2)	1~ 230 V	Heating Only (3)	Yes
		Heating / Cooling (4)	Yes
	1~ 24 V	Heating Only (3)	Yes
		Heating / Cooling (4)	Yes

- (1) There is no electric circuit inside the thermostat and electric power supply to the thermostat is not required.
- (2) Electric circuit such as display, LED, buzzer, etc is included in the thermostat and electric power supply is required.
- (3) Thermostat generates "Heating ON or Heating OFF" signal according to user's heating target temperature.
- (4) Thermostat generates both "Heating ON or Heating OFF" and "Cooling ON or Cooling OFF" signal according to user's heating and cooling target temperature.



CAUTION:

Choosing Heating / Cooling Thermostat

- Heating / Cooling Thermostat must have "Mode Selection" feature to distinguish operation mode.
- Heating / Cooling Thermostat must be able to assign heating target temperature and cooling target temperature differently.
- If above conditions are not kept, the unit can not operation properly.
- Heating / Cooling Thermostat must send cooling or heating signal immediately when temperature condition is satisfied. No delay time while sending cooling or heating signal is permitted.

12. Accessories Installation

12.5.3 How to Wire Thermostat

Follow below procedures Step 1 ~ Step 6.

Step 1. Uncover front cover of the unit and open the control box.

Step 2. Identify the power specification of the thermostat.

If it is 1~ 230 V, go to Step 4. Otherwise, if it is 1~ 24 V, go to step 3.

Step 3. Find thermostat connecting cable A and C. Disconnect cable A and C, then connect cable B and C.

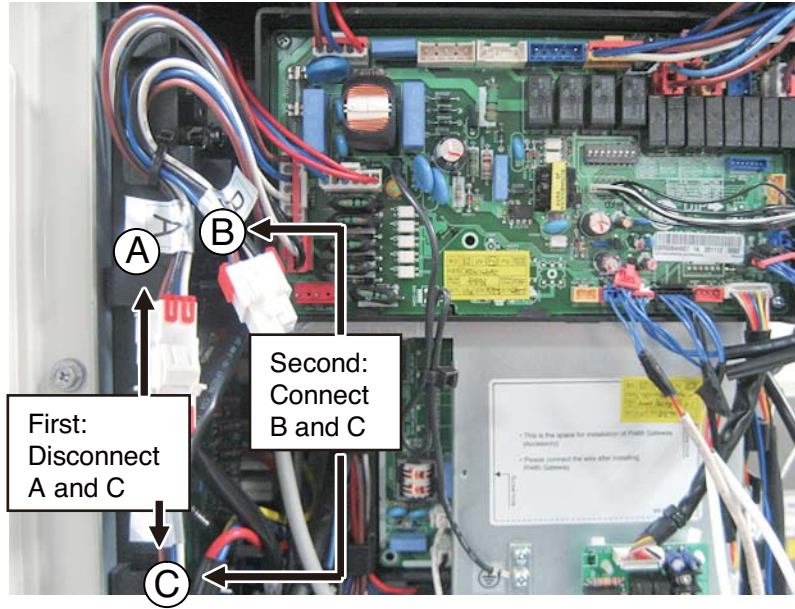

Step 4. If it is Heating Only Thermostat, go to step 5. Otherwise, if it is Heating / Cooling Thermostat, go to step 6.

Step 5. Find terminal block and connect wire as below. After connecting, go to step 6.

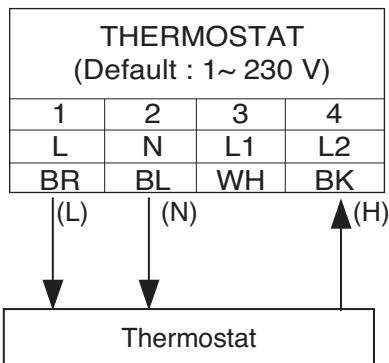

! WARNING :

Mechanical type Thermostat.

Do not connect wire (N) as mechanical type thermostat does not require electric power supply.

! CAUTION:

Do not connect external electric loads.

Wire (L) and (N) should be used only for operation Electric type thermostat. Never connect external electric loads such as valves, fan coil units, etc. If connected, Main PCB Assembly 1 can be seriously damaged.

- (L) : Live signal from PCB to Thermostat
- (N) : Neutral signal from PCB to Thermostat
- (H) : Heating signal from Thermostat to PCB

12. Accessories Installation

Step 6. Find terminal block and connect wire as below.

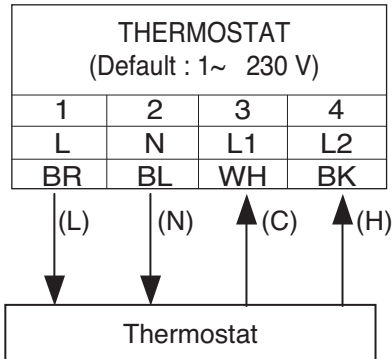

! WARNING :

Mechanical type Thermostat.

Do not connect wire (N) as mechanical type thermostat does not require electric power supply.

! CAUTION:

Do not connect external electric loads.

Wire (L) and (N) should be used only for operation Electric type thermostat. Never connect external electric loads such as valves, fan coil units, etc. If connected, Main PCB Assembly 1 can be seriously damaged.

- (L) : Live signal from PCB to Thermostat
- (N) : Neutral signal from PCB to Thermostat
- (C) : Cooling signal from Thermostat to PCB
- (H) : Heating signal from Thermostat to PCB

12.5.4 Final Check

- DIP switch setting :
Set DIP switch No. 8 to 'ON' (Check the system set-up of Chapter 7). Otherwise, the unit can not recognize the thermostat.
- Remote Controller :
 - 'Thermostat' icon is displayed on the remote controller.
 - Button input is prohibited.

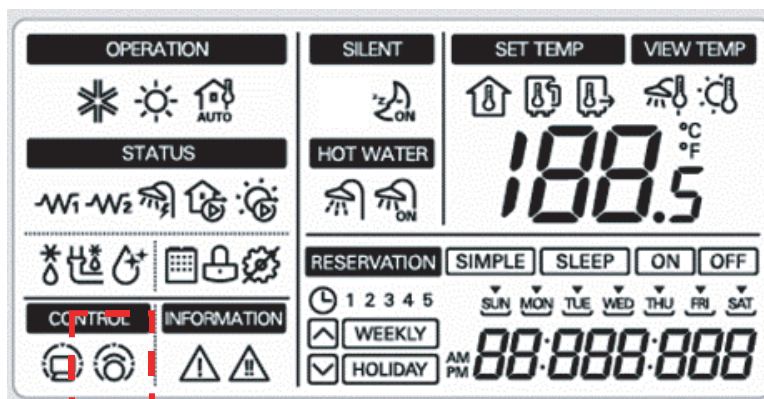





Thermostat Icon

12. Accessories Installation

NOTICE



Thermostat Operation with Remote Controller

Following features are permitted when thermostat is installed :

-  SET TEMP button
-  VIEW TEMP button
-  Temperature adjusting button (*)
-  Sanitary water heating button

(*) : The unit is not turned on/off according to the setting temperature at the remote controller.
It is turned on/off according to the thermostat signal

Following features are NOT permitted when thermostat is installed :

-  Operating mode (cooling/ heating/ weather-dependent) selection
-  Time scheduling
-  Operation On / Off

15.5.5 Sequence of thermostat operation

- How to set the heating temperature when thermostat is connected to the **Hydro Kit**.

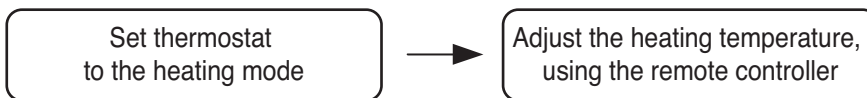

- How to set the cooling temperature when thermostat is connected to the **Hydro Kit**.

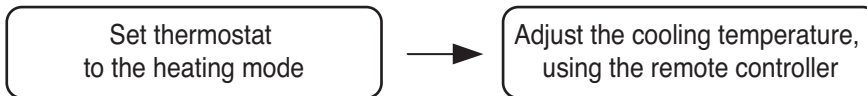

12. Accessories Installation

12.6 Remote Temperature Sensor

Remote temperature sensor can be installed any place a user wants to detect the temperature.

How to Install Remote Temperature Sensor

- Step 1.** After deciding where the remote temperature sensor is installed, decide the location and height of the fixing screws. (Interval between the screws : 60mm)
- Step 2.** Insert the connector of the connection wire into the space for the connector in place of the room temperature sensor.(CN_ROOM)
- Step 3.** Separately, set the option code of the attached controller on the indoor unit.
In detail, refer to "installer setting mode".
- Step 4.** The Connection wire does not matter if you change the color of the wire because of non-polar.

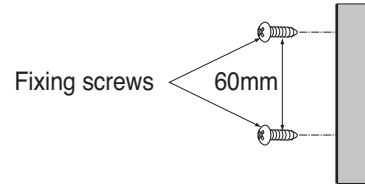

- Step 5.** Integrate the remote temperature sensor with the screws as the order of arrows.

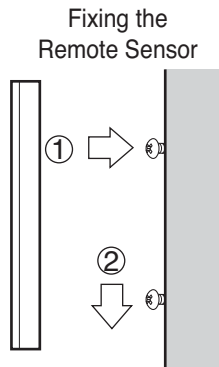

CAUTION:

1. Choose the place where the average temperature can be measured for the indoor unit operates.
2. Avoid direct sunlight.
3. Choose the place where the heating devices do not affect the remote sensor.
4. Choose the place where the outlet of the cooling fan do not affect the remote sensor.
5. Choose the place where the remote sensor isn't affected when door is open.

12. Accessories Installation

12.7 3Way Valve

3way valve is required to operate sanitary water tank. Role of 3way valve is flow switching between under floor heating loop and water tank heating loop.

12.7.1 General Information

Hydro Kit supports following 3way valve.

Type	Power	Operating Mode	Supported
SPDT 3-wire (1)	1~ 230 V	Selecting "Flow A" between "Flow A" and "Flow B" (2)	Yes
		Selecting "Flow B" between "Flow A" and "Flow B" (3)	Yes

(1) SPDT = Single Pole Double Throw. Three wires consist of Live (for selecting Flow A), Live 1 (for selecting Flow B), and Neutral (for common).

(2) Flow A means 'water flow from the unit to sanitary water tank'

(3) Flow B means 'water flow from the unit to under floor water circuit'

12.7.2 How to Wire 3Way Valve

Follow below procedures Step 1 ~ Step 2.

Step 1. Uncover front cover of the unit and open the control box.

Step 2. Find terminal block and connect wire as below.

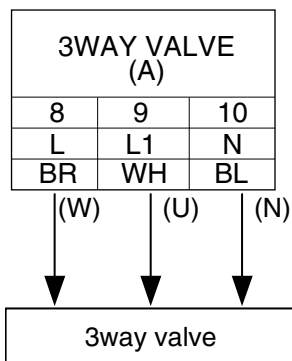

WARNING :

- 3way valve should select water tank loop when electric power is supplied to wire (W) and wire (N).
- 3way valve should select under floor loop when electric power is supplied to wire (U) and wire (N).

(W) : Live signal (Water tank heating) from PCB to 3way valve

(U) : Live signal (Under floor heating) from PCB to 3way valve

(N) : Neutral signal from PCB to 3way valve

WARNING :

Mice can not be appeared to prevent entering the unit or attacking wires.

12.7.3 Final Check

- Flow direction :
 - Water should flow from water outlet of the unit to sanitary tank water inlet when sanitary tank heating is selected.
 - To verify the flow direction, check temperature at the water outlet of the unit and water inlet of sanitary water tank.
 - If correctly wired, these temperatures should be almost equivalent if thermal insulation of water pipe is well performed.
- Noise or water pipe vibration while 3way valve operation
 - Due to surging effect or cavitation effect, noise or water pipe vibration can be occurred while 3way valve is operating.
 - In that case, check followings :
 - Is water circuit (both under floor water loop and sanitary water tank loop) fully charged? If not, additional water charging is required.
 - Fast valve operation yields noise and vibration. Appropriated valve operating time is 60~90 seconds.

12. Accessories Installation

12.8 2Way Valve

2way valve is required to control water flow while cooling operation. Role of 2way valve is to cut off water flow into under floor loop in cooling mode when fan coil unit is equipped for cooling operation.

12.8.1 General Information

Hydro Kit supports following 2way valve.

Type	Power	Operating Mode	Supported
NO 2-wire(1)	230V AC	Closing water flow	Yes
		Opening water flow	Yes
NC 2-wire(2)	230V AC	Closing water flow	Yes
		Opening water flow	Yes

(1) : Normal Open type. When electric power is NOT supplied, the valve is open.

(When electric power is supplied, the valve is closed.)

(2) : Normal Closed type. When electric power is NOT supplied, the valve is closed.

(When electric power is supplied, the valve is open.)

12.8.2 How to Wire 2Way Valve

Follow below procedures Step 1 ~ Step 2.

Step 1. Uncover front cover of the indoor unit and open the control box.

Step 2. Find terminal block and connect wire as below.

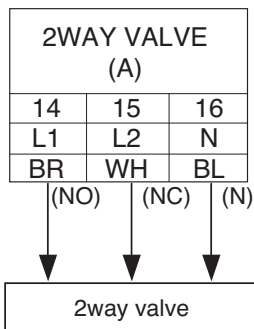

CAUTION :

Dew Condensation

- Wrong wiring can yield dew condensation on the floor. If radiator is connected at the under floor water loop, dew condensation can be occurred on the surface of the radiator.

WARNING :

Wiring

- Normal Open type should be connected to wire (NO) and wire (N) for valve closing in cooling mode.

(NO) : Live signal (for Normal Open type) from PCB to 2way valve

(NC) : Live signal (for Normal Closed type) from PCB to 2way valve

(N) : Neutral signal from PCB to 2way valve

12.8.3 Final Check

- Flow direction :
 - Water should not flow into under floor loop in cooling mode.
 - To verify the flow direction, check temperature at the water inlet of the under floor loop.
 - If correctly wired, this temperatures should not be approached to 6°C(42°F) in cooling mode.

12. Accessories Installation

12.9 Dry Contact

LG Dry Contact is a solution for automatic control of HVAC system at the owner's best.

In simple words, it's a switch which can be used to turn the unit On/Off after getting the signal from external sources like key-in lock, door or window switch etc specially used in Hotel rooms.

How to Install Dry Contact

Connect CN_DRY with Control Unit.

- To apply power source through Dry Contact PCB.

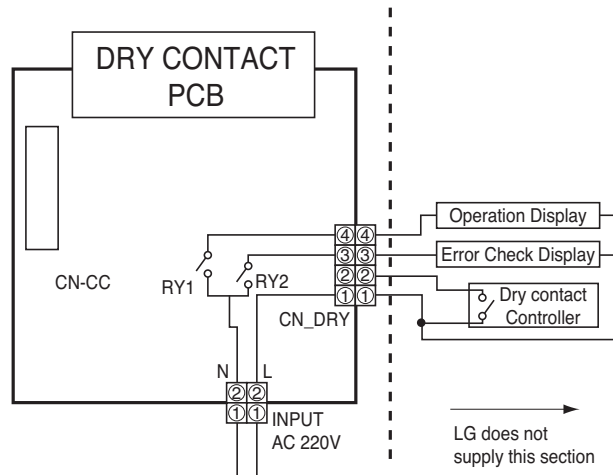

- To apply power source directly to external source.

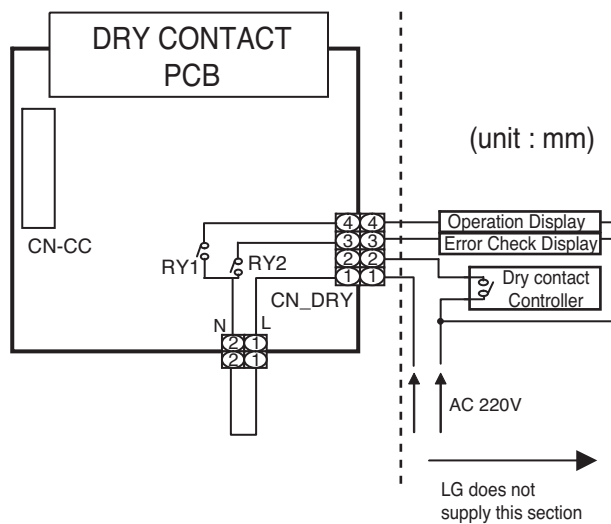

13. System Set-Up

As **Hydro Kit** (For Medium Temperature) is designed to satisfy various installation environment, it is important to set up system correctly. If not configured correctly, improper operation or degrade of performance can be expected.

13.1 Dip switch setting

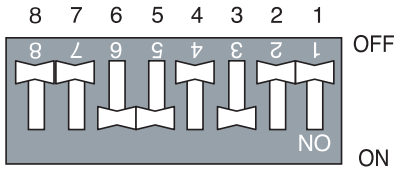

- Turn off electric power supply before setting dip switch. There is risk of electric shock.
- Dip switch is turned on when pulled down.
- Always set dip switch #6 to ON and #7 to OFF.
- If dip switch is not set as below, the unit may not operate properly.

x : OFF ● : On

Description	Dip switch setting								Function	Default
	1	2	3	4	5	6	7	8		
Group Control	x								Master	○
	●								Slave	
Installation Scene		x	x						Floor heating only	
		●	x						Floor heating + Hot water + solar booster	
		x	●						Floor heating + Hot water	○
		●	●						Hot water only	
Emergency operation				x					High temperature operation	○
				●					Low temperature operation	
Water pump control					x				Water pump controlled with Hydro Kit	
					●				Water pump NOT controlled with Hydro Kit	○
Thermostat connection								x	Thermostat NOT installed	○
								●	Thermostat installed	

13. System Set-Up

13.2 Group Control Setting

Group Control

- Wired remote controller 1 + Many of **Hydro Kit**

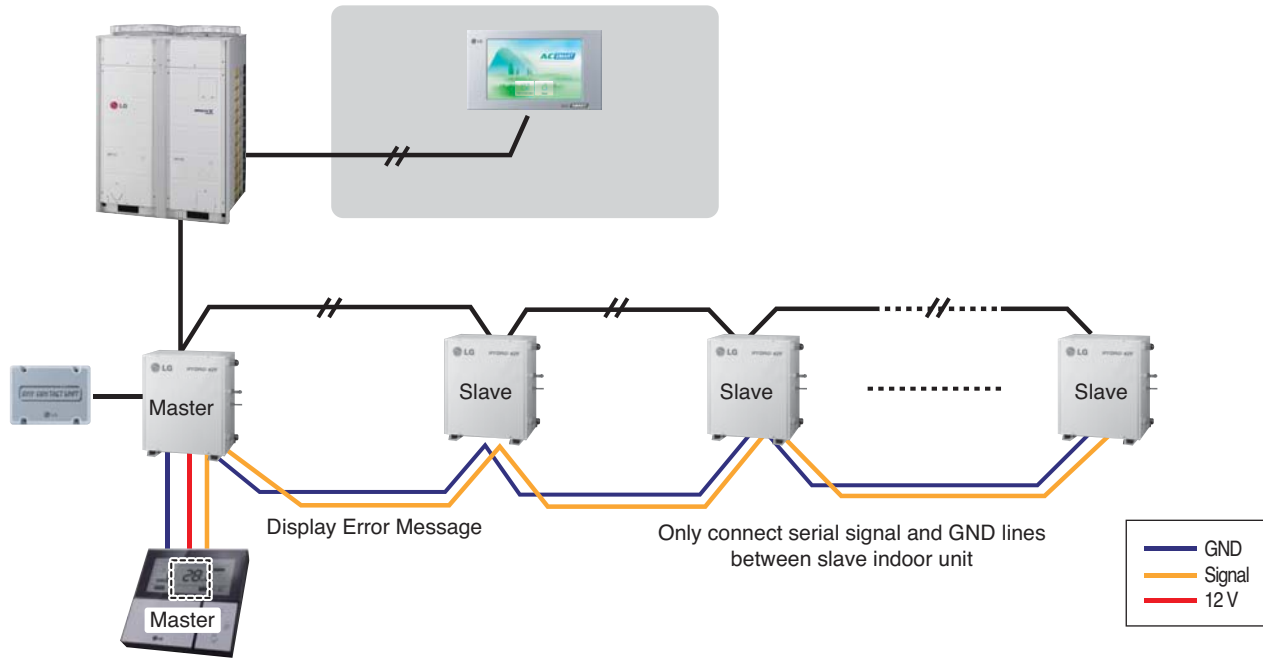

Hydro Kit (Medium Temp.)

- Dip Switch in PCB

① **Master Setting**
- No. 1 Off

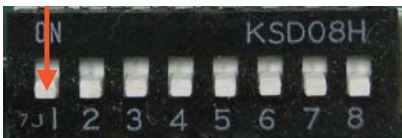

② **Slave Setting**
- No. 1 On



1. It is possible to connect 16 indoor units(Max) by one wired remote controller.

Set only one indoor unit to Master, set the others to Slave.

2. You can connect all the types of 2nd generation indoor units .

3. It is possible to use wireless remote controller at the same time.

4. It is possible to connect Dry Contact and Central controller at the same time.

- The Master indoor unit is possible to recognize Dry Contact and Central Controller only.
- In case of Central controller and Group controller at the same time, it is possible to connect standard 2series indoor units or later since Feb. 2009.
- In case of Central controller setting, the Central controller can control indoor units after setting only the address of master indoor unit.
- Slave indoor unit will be operated like master indoor unit.
- Slave indoor unit can not be individually controlled by Central controller.
- Some remote controller can't perform with Dry Contact and Central controller at the same time. So contact us further information about it.

13. System Set-Up

5. In case that the indoor unit has an abnormal problem an error code will be displayed on the wired remote controller.
With the exception of the indoor unit with the error, you can control each indoor unit individually.
 6. In case of Group Control, it is possible to use following functions.
 - Selection of operation options (operation/stop/mode/set temperature)
 - Control of flow rate (High/Middle/Low)
 - It is not possible at some functions.
- ※ Master/Slave setting of indoor units be set possible using a PCB Dip Switch.
- ※ It is possible to connect indoor units since Feb. 2009.
In the other cases, please contact LGE.
- ※ It can be the cause of malfunctions when there is no setting of master and slave.

Accessories for group control setting

- Accessories for group control setting

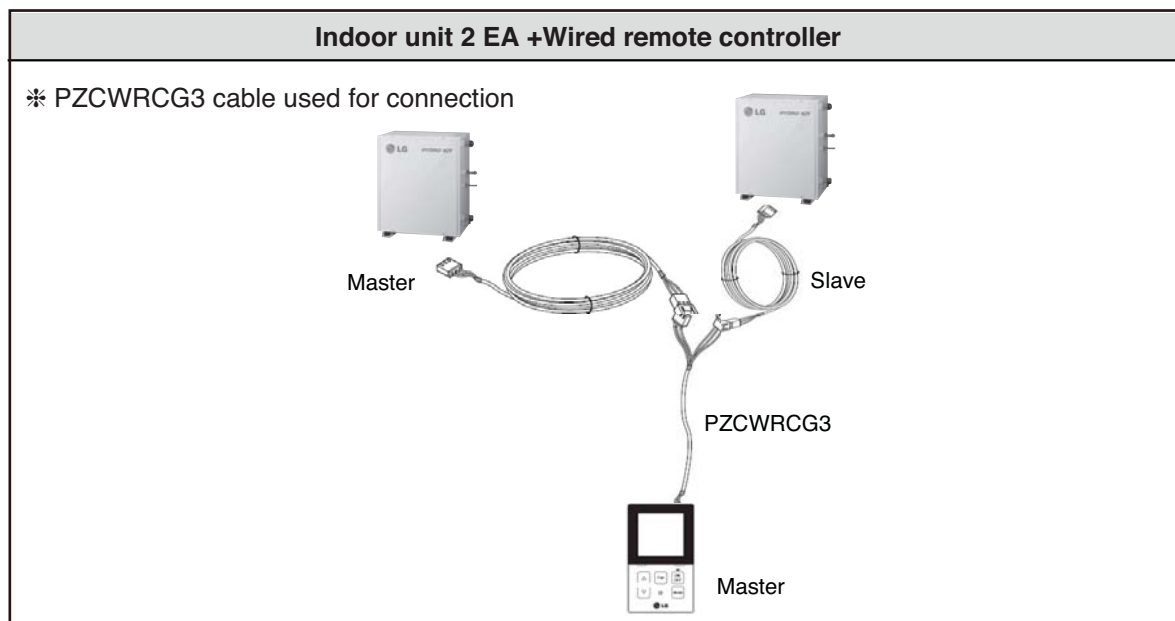

NOTICE

Emergency Operation

• Definition of terms

- **Trouble** : a problem which can stop system operation, and can be resumed temporally under limited operation without certificated professional's assist.
- **Error** : problem which can stop system operation, and can be resumed ONLY after certificated professional's check.
- **Emergency mode** : temporary heating operation while system met Trouble.

• Objective of introducing 'Trouble'

- Not like airconditioning unit, **Hydro Kit** is generally operated in whole winter season without any system stopping.
- If system found some problem, which is not critical to system operating for yielding heating energy, the system can temporarily continue in emergency mode operation with end user's decision.

• Classified Trouble

- Trouble is classified two levels according to the seriousness of the problem : Slight Trouble and Heavy trouble
- **Slight Trouble** : Sensor trouble.
- **Heavy trouble** : Compressor cycle trouble.
- **Option Trouble** : a problem is found for option operation such as water tank heating. In this trouble, the troubled option is assumed as if it is not installed at the system.





• Emergency operation level

- When the system is faced with trouble, it stops and waits for user's decision : Calling service center or starting emergency operation.
- To start emergency operation, user simply push ON / OFF button once more.
- Two different levels are prepared for emergency operation : High temperature cycle and low temperature cycle.
- In emergency operation mode, user can not adjust target temperature.

	DIP Switch (No.4)	Target Leaving Water Temperature	Target Room Air Temperature	Target Sanitary Water Temperature
High temperature cycle	OFF	50°C(122°F)	24°C(75°F)	50°C(122°F)
Low temperature cycle	ON	30°C(86°F)	19°C(66°F)	50°C(122°F)

13. System Set-Up

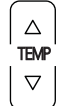

• **Following features are permitted in emergency operation :**

-  Operation On/Off
-  VIEW TEMP button(*)
-  Temperature adjusting button (**)
-  Sanitary water heating button

(*) : Temperature measured by failed sensor is displayed as '- -'.

(**) : The unit is not turned on/off according to the setting temperature at the remote controller.
It is turned on/off according to the thermostat signal

• **Following features are NOT permitted in emergency operation :**

-  Operating mode (heating/ weather-dependent) selection
-  Time scheduling
-  SET TEMP button

• **Duplicated trouble : Option trouble with Slight or Heavy trouble**

If option trouble is occurred with slight (or heavy) trouble at the same time, the system puts higher priority to slight (or heavy) trouble and operates as if slight (or heavy) trouble is occurred.

Therefore, sometimes sanitary water heating can be impossible in emergency operation mode. When sanitary water is not warming up while emergency operation, please check whether the sanitary water sensor and related wiring are connected well or not.

• **Emergency operation is not automatically restarted after main electricity power is reset.**

In normal condition, the unit operating information is restored and automatically restarted after main electricity power is reset.

But in emergency operation, automatic re-start is prohibited to protect the unit.

Therefore, user must restart the unit after power reset when emergency operation has been running.

13. System Set-Up

13.3 Installer Setting

How to enter installer setting mode



CAUTION:

Installer setting mode is to set the detail function of the remote controller. If the installer setting mode is not set correctly, it could cause problems to the unit, user injury or property damage. This must be set by an certificated installer, and any installation or change that is carried out by a non-certificated person should be responsible for the results. In this case, free service cannot be provided.

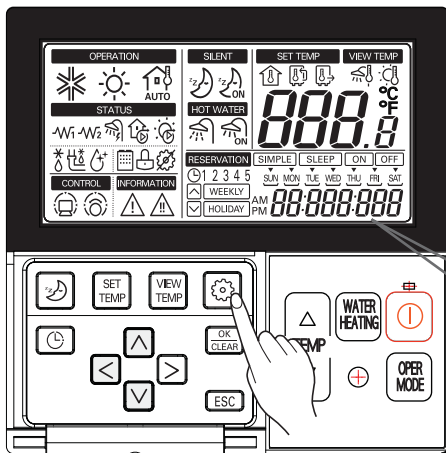

1 Press Function Setting button for 3 seconds to enter the installer setting mode.

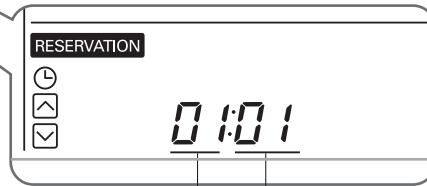
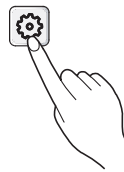

Function Code Value

(When you enter the installer setting mode initially, function code is displayed on the bottom of the LCD screen.)

Repeat pressing button, and the function code will be changed from 01 to 2B.
Please refer the code table on the next page.

13. System Set-Up

Summary

Example of Fuction Code Display

02:00 : 155

Function Code Value #1 Value #2

Function	Default	Value #1	Value #2	Remark
Test Run	01:01	01 : Set	-	
Disable 3 Min. Delay	02:01	01	-	
Remote Air Sensor Connection	03:01	01 : NOT connected. 02 : connected.	-	
Celsius/Fahrenheit Switching	04:01	01 : Celsius 02 : Fahrenheit	-	
Setting Temp. Selection	05:02	01 : Air Temp. 02 : Leaving water Temp.	-	
Auto Dry Contact	06:01	01 : Auto Start OFF 02 : Auto Start ON	-	
Address Setting	07:00	00 ~ FF	-	
Override Setting	08:00	00 : Slave 01 : Master	-	
Water Pump Test Run	09:00	01 : Set		
Setting Air Temp. (cooling Mode)	11:030:018	24°C(75°F)~30°C(86°F) : Upper Limit of setting range	18°C(64°F)~22°C(71°F) : Lower Limit of setting range	
Setting Leaving Water Temp. (cooling Mode)	12:024	20°C(68°F)~25°C(77°F) : Upper Limit of setting range	-	
	12:006:016	06°C(42°F)~18°C(64°F) : Lower Limit of setting range	16°C(60°F)~18°C(64°F) : Lower Limit of setting range	
Setting Air Temp. (Heating Mode)	13:030:016	24°C(75°F) ~ 30°C(86°F) : Upper Limit of setting range	16°C(60°F) ~ 22°C(71°F) : Lower Limit of setting range	
Setting Leaving Water Temp. (Heating Mode)	14:050:020	35°C(95°F)~50°C(122°F) : Upper Limit of setting range	20°C(68°F)~34°C(93°F) : Lower Limit of setting range	
Setting Sanitary Tank Water Temp. (Sanitary Water Heating)	15:050:040	50°C(122°F) : Upper Limit of setting range	30°C(86°F)~40°C(104°F) : Lower Limit of setting range	
Setting Cut-off Temp. (FCU Cooling Mode)	22:016:000	16°C(60°F)~25°C(77°F)	00 : FCU is installed 01 : FCU is NOT installed	
Setting outdoor Temp. range (Weather-dependent operation)	23:-10:015	10°C(50°F) ~ 20°C(68°F) : Upper Limit of setting range	-20°C(-4°F) ~ 05°C(41°F) : Lower Limit of setting range	
Setting indoor air Temp. range (Weather-dependent operation)	24:021:016	20°C(68°F) ~ 30°C(86°F) : Upper Limit of setting range	16°C(60°F) ~ 19°C(66°F) : Lower Limit of setting range	
Setting leaving water Temp. (Weather-dependent operation)	25:050:020	35°C(95°F)~50°C(122°F) : Upper Limit of setting range	20°C(68°F)~34°C(93°F) : Lower Limit of setting range	
Setting control parameter (Sanitary water heating operation)	28:005:050	01°C(33°F) ~ 20°C(68°F) : Temp. gap from Value #2	40°C(104°F)~50°C(122°F)	
Setting control parameter (Sanitary water heating operation)	29:003:000	02°C(35°F) ~ 04°C(39°F)	00~01	
Sanitary water heating timers	2b:030	5 ~ 95 min (step: 5 min)	-	
	2b:180:020	0 ~ 600 min (step: 30 min)	20 ~ 95 min (step: 5 min)	
Setting Water Flow Rate	2c:92	15~92 LPM	-	
Change thermal on/off Air Temp.	2E:00	00~03	-	
Change thermal on/off Leaving Water Temp.	2F:00	00~03	-	
Program version	30:***	***	-	



CAUTION:

*Temp. = Temperature

There is no disinfection function in Hydro Kit. So, external control equipment should be installed for disinfection function.

Common Setting

• **Function Code 01** : Test Run

Test run should be performed when charging the additional refrigerant is required. The unit must be operated in Cooling mode when the refrigerant is being charged. Test run instantly makes the unit operate in Cooling mode for 18 minutes.

Note : • If you press any kind of button during this mode, Test Run mode will be finished.
• After the unit operates under Test run mode for 18 minutes, it will be turned off automatically

• **Function Code 02** : Disable 3 minute Delay

Only used for an inspection in a factory.

• **Function Code 03** : Remote Air Sensor Connection

If remote air sensor is connected to control the unit by room air temperature, the connection information should be notified to the unit.

Note : If remote air sensor is connected but this function code is not set correctly, the unit can not be controlled by room air temperature.

• **Function Code 04** : Celsius/Fahrenheit Switching

Temperature is displayed in Celsius or Fahrenheit.

• **Function Code 05** : Setting Temperature Selection

The unit can be operated according to air temperature or leaving water temperature. The selection for setting temperature as air temperature or leaving water temperature is determined.

Note : Air temperature as setting temperature is ONLY available when Remote Air Sensor Connection is enabled and Function Code 03 is set as 02.

• **Function Code 06** : Auto Dry Contact

This function enables the Dry Contact to operate under Auto Run mode or Manual mode with remote controller.

If thermostat is used, value should be changed from "2" to "1".

• **Function Code 07** : Address Setting

When Central Controller is installed, address assigning is set by this function.

• **Function Code 08** : Override Setting

Override master/slave selection function is to prevent the unit's different mode operation. If the unit is set as the slave, it blocks a change of opposite operating mode(cooling/heating).

※ To use override master/slave selection function is only possible when units are connected in series to the outdoor unit.

• **Function Code 09** : Water Pump Test Run

After water pipe work is done, Water Pump Test Run mode should be performed to check whether water circulation is normal.



13. System Set-Up

Temperature Range Setting

- **Function Code 11** : Setting Air Temperature in Cooling Mode
Determine cooling setting temperature range when air temperature is selected as setting temperature.

NOTICE

Only available when remote air temperature sensor is connected.

- Accessory PQRSTA0 should be installed.
- Also, Function Code 03 should be set properly.

- **Function Code 12** : Setting Leaving Water Temperature in Cooling Mode
Determine cooling setting temperature range when leaving water temperature is selected as setting temperature.

NOTICE

Water condensation on the floor

- While the unit operates in cooling mode it is very important to keep leaving water temperature higher than 16°C(60°F). Otherwise, dew condensation can occur on the floor.
- If floor is in humid environment, do not set leaving water temperature below 18°C(64°F).

NOTICE

Water condensation on the radiator

- While the unit operates in cooling mode cold water may not flow to the radiator. If cold water enters to the radiator, dew generation on the surface of the radiator can occur.

- **Function Code 13** : Setting Air Temperature in Heating Mode
Determine heating setting temperature range when air temperature is selected as setting temperature.



CAUTION:

Only available when remote air temperature sensor is connected.

- Accessory PQRSTA0 should be installed.
- Also, Function Code 03 should be set properly.

- **Function Code 14** : Setting Leaving Water Temperature in Heating Mode
Determine heating setting temperature range when leaving water temperature is selected as setting temperature.

- **Function Code 15** : Setting Sanitary Tank Leaving Water Temperature
Determine heating setting temperature range of water tank leaving water.

NOTICE

Only available when sanitary water tank temperature sensor is installed.

- Sanitary water tank and sanitary water tank kit should be installed.
- DIP switch No. 2 and 3 should be set properly.

Temperature Control Parameter Setting and Etc

- **Function Code 22** : Setting Cut-off Temperature in Cooling Mode (FCU setting included)
Determine leaving water temperature when the unit is turned off. This function is used for preventing condensation on the floor in cooling mode.
 - Value #1 : cut-off temperature. Value #1 is valid when Value #2 is '00 (that means, FCU is installed)'.
- Value #2 : determines if FCU is installed or not. '01' means 'FCU is NOT installed', and '00' means 'FCU is installed.'
- Example : If Value #1 is set as '10' and Value #2 is '01' and actually FCU is NOT installed in the water loop, the unit stops operation in cooling mode when the leaving water temperature is below 10°C(50°F).
- Example : If Value #1 is set as '10' and Value #2 is '00' and actually FCU is installed in the water loop, the unit does NOT stop operation in cooling mode when the leaving water temperature is below 10°C(50°F).

NOTICE

FCU Installation

- If FCU is used, 2way valve should be installed and connected to the Main PCB assembly 1.
 - If Value #2 is set as '00' but FCU or 2way valve is NOT installed, the unit may not operate normally.
- **Function Code 23, 24, and 25** : Setting Weather-dependent operation
Weather-dependent operation is that the unit automatically adjusts target temperature (leaving water or room air) according to the outdoor air temperature.
 - Value #1 and Value #2 of Function Code 23 : range of outdoor air temperature
 - Value #1 and Value #2 of Function Code 24 : range of auto-adjustable target room air temperature
 - Value #1 and Value #2 of Function Code 25 : range of auto-adjustable target leaving water temperature
- Note** : Weather-dependent operation is applied for heating mode only.

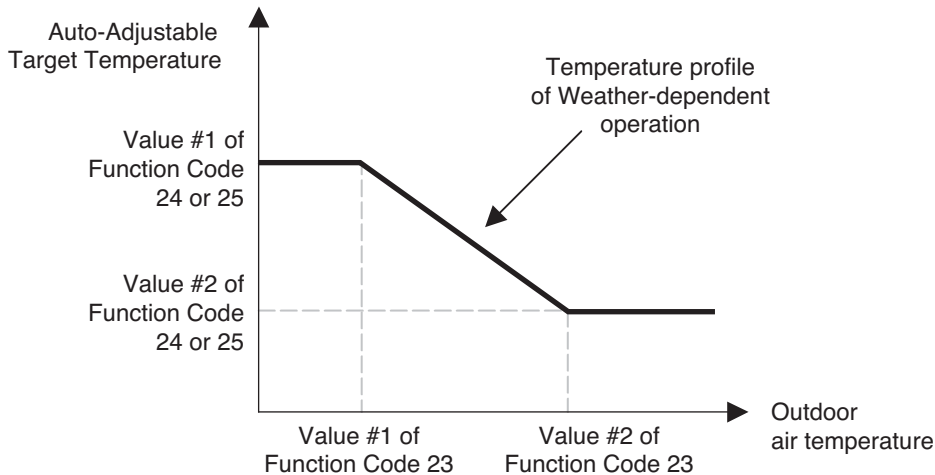

13. System Set-Up

• **Function Code 26 and 27** : Setting Disinfection operation

Disinfection operation is special sanitary tank operation mode to kill and to prevent growth of viruses inside the tank.

- Value #1 of Function Code 26 : Selecting disinfection operation mode. '00' for setting disinfection mode off, and '01' for setting disinfection mode on.
- Value #2 of Function Code 26 : Determining the date when the disinfection mode is running. '01' for Sunday, '02' for Monday, ... , and '06' for Saturday.
- Value #3 of Function Code 26 : Determining the time when the disinfection mode is running. '00' for 0:00am, '01' for 01:00am, ... , '22' for 10:00pm, and '23' for 11:00pm.
- Value #1 of Function Code 27 : Target temperature of disinfection mode.
- Value #2 of Function Code 27 : Duration of disinfection mode.

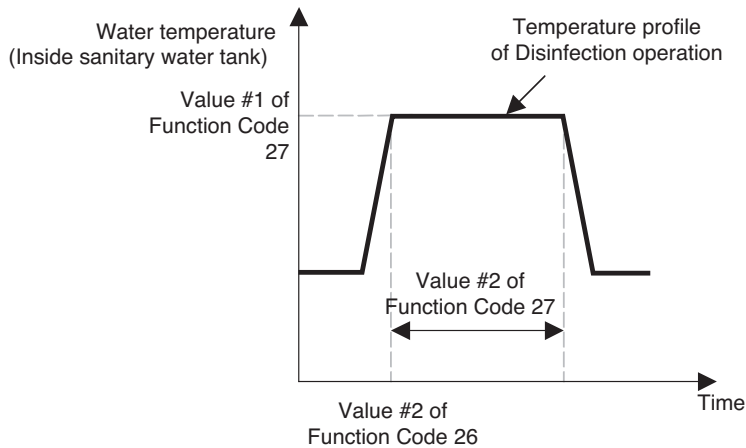

WARNING:

Vales of Function Code 26

- If Value #1 of Function Code 26 is set as '00', Value #2 and Value #3 is not used.
- When Value #1 is set as '01', Value #2 is displayed at the position of Value #1 and Value #3 is displayed at the position of Value #2 due to limited width of the control panel display.

CAUTION:

Sanitary water heating should be enabled

- If sanitary water heating is disabled, the disinfection mode will not be operated although Value #1 of Code 26 is set as '01'.
- To use disinfection mode, sanitary water heating should be enabled.

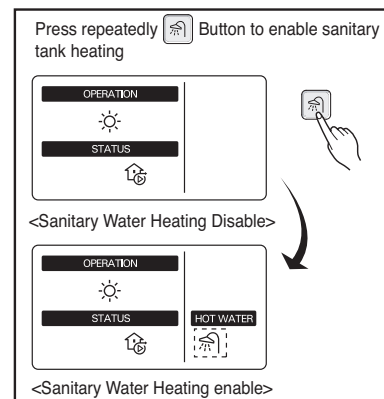

13. System Set-Up

- **Function Code 28 and 29** : Setting control parameter for Sanitary water heating operation

Descriptions for each parameters are as following.

- Value #1 of Function Code 28 : temperature gap from Value #2 of Function Code 28.
- Value #2 of Function Code 28 : maximum temperature.
- Example : If Value #1 is set as '5' and Value #2 is set as '50', then water tank heating will be started when the water tank temperature is below 45°C(113°F).
- Value #1 of Function Code 29 : temperature gap from target sanitary water temperature.
- Value #2 of Function Code 29 : Determining heating demand priority between sanitary water tank heating and under floor heating.
- Example : If user's target temperature is set as '50' and Value #1 is set as '3', then water tank heating will be turned off when the water temperature is above 53°C(127°F). Water tank heating will be turned on when the water temperature is below 50°C(122°F).
- Example : If Value #2 is set as '0', that means heating priority is on sanitary water heating, In this case the under floor can not be heated while sanitary water heating. On the other hand, if the Value #2 is set as '1', that means heating priority is on under floor heating, sanitary tank can not be heated while under floor heating.

NOTICE

Sanitary water heating does not operate when it is disabled.

Enabling / Disabling sanitary water heating to operate is determined by pushing  button.

When  icon is displayed on the remote controller, sanitary water heating is enabled.
(by button input or scheduler programming)

- **Function Code 2B** : Setting sanitary water heating timers

Determine time duration : Operation time and stop time of sanitary tank heating

- Value #1 of Function Code 2B : This time duration defines how long sanitary tank heating can be continued.
- Value #2 of Function Code 2B : This time duration defines how long sanitary tank heating can be stopped. It is also regarded as time gap between sanitary tank heating cycle.
- Example of timing chart :

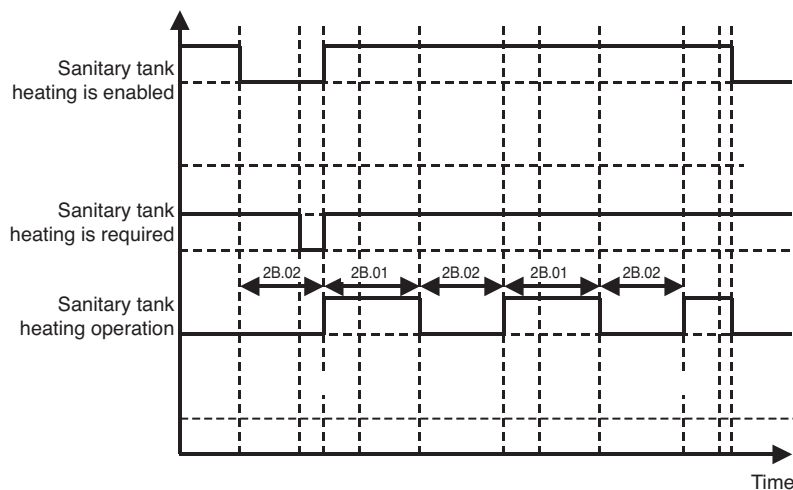

13. System Set-Up

- **Function Code 2C** : Setting water flow rate

Determine the difference between target inlet water temperature and target outlet water temperature from water flow rate.

- Value #1 of Function Code 2C : Water flow rate which flows to **Hydro Kit**.

- **Function Code 2E and 2F** : Changing thermal on/off temperature

Select Thermal on/off Temperature gap.

2E : Room Air temperature

	Th On	Th Off
0	-0.5°C	1.5°C
1	4°C	6°C
2	2°C	4°C
3	-1°C	1°C

2F : Leaving Water temperature

	Th On	Th Off
0	-2°C	2°C
1	-6°C	4°C
2	-2°C	4°C
3	-1°C	1°C

- **Function Code 30** : Remote Controller Program Version

Display Remote Controller Program Version.

14. Test Run

14.1 Caution before Operation Test

- Check whether water flow is smoothly supplied.
- Check whether the flow switch properly operates.
- Check whether the connection status is good.
- Check whether the power cable and communication cable are completely connected.
- Check whether it is 2.0MΩ or above, when insulation resistance between the terminal block and ground is measured with DC mega tester (DC 500V).
- Never check insulation resistance for the connector of the control board.

14.2 Operation Test of Water Pipe

Category	Status	Check point
Flow Switch Error	CH14	Check whether operation of water pipe is normal.
		Check for the block inside water pipe.
		(Strainer cleaning, valve locked, valve malfunction, air remaining, etc.)
		Check problem with flow switch.
		(Flow switch disorder, untold operation, disconnection, etc.)

14.3 Troubleshooting

- This function displays the disorder types at the self diagnostics and the occurrence of the disorder for the product.
 - The disorder display shows the code in the following table on the red/green LED of the wired remote controller and outdoor unit control board.
 - If two or more types of disorders occur simultaneously, it displays in the order of the error number.
 - After error occurs, the error code disappears when the disorder is repaired.
- * Error code 01, 08, 17, 18 can be operated with emergency operation.

Error No.	Error Type	Main Reasons
01	Air temperature sensor error	Air temperature sensor disconnection or short circuit
02	Gas side temperature sensor error	Gas side temperature sensor disconnection or short circuit
03	No communication between wired remote controller & indoor unit	The remote controller does not receive the signal from indoor unit during specific time
05	Indoor unit & outdoor unit communication error	No signal communication between indoor unit & outdoor unit
06	Liquid side temperature sensor error	Liquid side temperature sensor disconnection or short circuit
08	Water tank temperature sensor error	Water tank temperature sensor disconnection or short circuit
09	Indoor unit EEPROM error	Communication between the micro-processor & the EEPROM / Error due to EEPROM damage
13	Solar thermal temperature sensor error	Solar thermal temperature sensor disconnection or short circuit
14	Flow switch error	Abnormal working of flow switch
15	Water pipe overheated	Water outlet temperature is above 90°C
16	Water inlet & outlet temperature sensor error	Water inlet & outlet temperature sensor disconnection or short circuit simultaneously
17	Water inlet temperature sensor error	Water inlet temperature sensor disconnection or short circuit
18	Water outlet temperature sensor error	Water outlet temperature sensor disconnection or short circuit

MULTI V Indoor unit **Hydro Kit**

Hydro Kit (High Temp.)

- 1. List of functions**
- 2. Specifications**
- 3. Dimensions**
- 4. Piping Diagrams**
- 5. Wiring Diagrams**
- 6. Capacity correction factor**
- 7. Water Pressure Drop**
- 8. Operation Limits**
- 9. Electric Characteristics**
- 10. Sound Levels**
- 11. Installation**
- 12. Accessories Installation**
- 13. System Set-Up**
- 14. Test Run**

1. List of functions

1.1 List of functions

Category	Functions	ARNH08GK3A2
Installation	Drain pump	X
	E.S.P. control	X
	Electric heater	X
	High ceiling operation	X
	Auto Elevation Grille	X
Reliability	Hot start	X
	Self diagnosis	O
	Soft dry operation	X
Convenience	Auto changeover	X
	Auto cleaning	X
	Auto operation(artificial intelligence)	X
	Auto Restart	O
	Child lock	O
	Forced operation	X
	Group control	O
	Sleep mode	X
	Timer(on/off)	O
	Timer(weekly)	O
Individual control	Two thermistor control	X
	Standard Wired remote controller	O
	Deluxe wired remote controller	X
	Simple wired remote controller	X
	Simple Wired remote controller(for hotel use)	X
CAC network function	Wireless remote controller	X
	General central controller (Non LGAP)	X
	Network Solution(LGAP)	O
	Dry contact	PQDSA(1) / PQDSB(1)
	PDI(power distribution indicator)	X
Special function kit	PI 485	X
	Zone controller	X
	CTI(Communication transfer interface)	X
Others	Electronic thermostat	X
	Remote temperature sensor	PQRSTA0
Hydro Kit	Telecom shelter controller	X
	Anti-condensation on floor(cooling)	X
	Water pump on / off Control	O
	Flow switch control	O
	Thermostat interface (230V AC)	O
	Thermostat interface (24V AC)	X
	Sanitary tank heating	O
	Solar-thermal interface with sanitary tank	X
	PHEX anti-freezing control	O
	Water pump forced operation	O
	Autosetting according to ambient temperature	O
	Silent operation	X
	Anti-overheating of water pipe	O
Emergency operation	O	

Notes

O : Applied, X : Not applied

Accessory model name : Installed at field, ordered and purchased separately by the corresponding model name, supplied with separate package.

1. List of functions

1.2 Accessory List

Device		ARNH08GK3A2
Central Controller	Simple Controller	X
	Function controller	X
	Function Scheduler	X
	AC Ez	X
	AC Smart II	PQCSW320A1E
	128 Unit Expansion Kit	PQCSE440U0
	Option Kit (SD card type)	PQCSE342A0
	ACP(Advanced Control Platform)	PQCPB11A0E
	AC Manager	PQCSS520A0E
	DO(Digital Output) Kit	X

Notes

O : Applied, X : Not applied

Accessory model name : Installed at field, ordered and purchased separately by the corresponding model name, supplied with separate package.

2. Specifications

Type				Hydro Kit (High Temp.)	
Model		Unit		ARNH08GK3A2	
Power Supply		V / Ø / Hz		220-240 / 1 / 50 220 / 1 / 60	
Capacity (Rated)	Cooling	kW		-	
		kcal/h		-	
		Btu/h		-	
	Heating	kW		25.2	
		kcal/h		21,700	
Btu/h		86,000			
Input (Rated)	Cooling	kW		-	
	Heating	kW		5.00	
Casing				Painted Steel Plate	
Dimensions	Body	W x H x D	mm	520 x 1,080 x 330	
			inch	20-15/32 x 42-17/32 x 13	
Net Weight	Body			kg (lbs)	94.0 (207.2)
Heat Exchanger	Refrigerant to Water	Type		Brazed Plate HEX	
		Quantity		EA	1
		Number of Plate		EA	48
		Rated Water Flow		l / min	36.0
	Head Loss		kPa	20.0	
	Refrigerant to Refrigerant	Type		Brazed Plate HEX	
		Quantity		EA	1
Number of Plate		EA	60		
Compressor	Type		Twin Rotary inverter		
	Piston Displacement		cm ³ /rev	52.5	
	Number of Revolution		rev/min	3,600	
	Motor Output x Number		W x No.	4,000 x 1	
	Starting Method		Direct On Line		
	Oil Type		FVC68D(PVE)		
	Oil Charge		cc	1,300	
Temperature Control				Microprocessor, Thermostat for heating	
Sound Absorbing Thermal Insulation Material				Foamed polystyrene	
Safety Device				Fuse	
Piping Connections	Water Side	Inlet	inch	Male PT 1	
		Outlet	inch	Male PT 1	
	Refrigerant Side	Liquid	mm(inch)	Ø 9.52(3/8)	
		Gas	mm(inch)	Ø 19.05(3/4)	
Drain Piping Connection			inch	Male PT 1	
Sound Pressure Level	Cooling			dB(A)	-
	Heating			dB(A)	43
Power Supply Cable		No. x mm ²		3C x CV4.0	
Communication cable		No. x mm ²		2C x CVV-SB 1.0~1.5	
Refrigerant	Refrigerant to Refrigerant	Refrigerant name		R410A	
		Control		Electronic Expansion Valve	
	Refrigerant to Water	Refrigerant name		R134a	
		Precharged Amount		kg (lbs)	3.0 (6.6)
		Control		Electronic Expansion Valve	

Notes:

- Capacities are based on the following conditions:
 - Cooling Temperature : Indoor 27°C(80.6°F) DB / 19°C(66.2°F) WB
Outdoor 35°C(95°F) DB / 24°C(75.2°F) WB
Water Inlet 23°C(73.4°F) / Outlet 18°C(64.4°F)
 - Heating Temperature : Indoor 20°C(68°F) DB / 15°C(59°F) WB
Outdoor 7°C(44.6°F) DB / 6°C(42.8°F) WB
Water Inlet 55°C(131°F) / Outlet 65°C(149°F)
 - Difference Limit of Elevation (Outdoor ~ Indoor Unit) is Zero.
 - Piping Length : Interconnected Pipe Length = 7.5m
- Wiring cable size must comply with the applicable local and national code.
- Due to our policy of innovation, some specifications may be changed without notification.
- Sound Level Values are measured at Anechoic chamber.
Therefore, these values can be increased (maximum 3dB(A)) owing to ambient conditions during operation.

3. Dimensions

K3 Chassis

ARNH08GK3A2

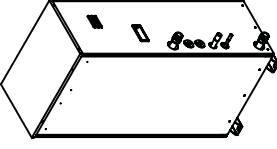

3D View

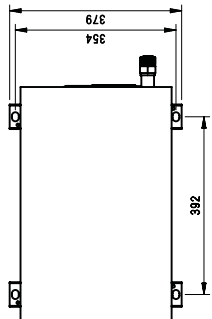

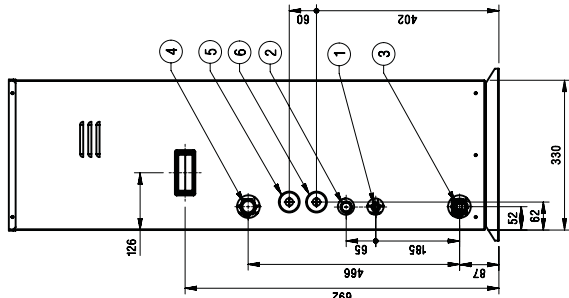

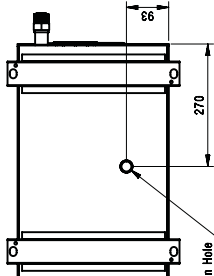

∅22 Drain Hole

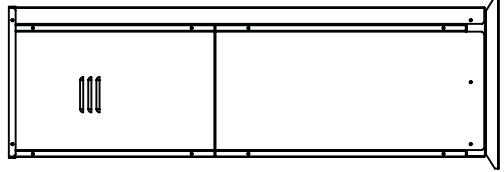

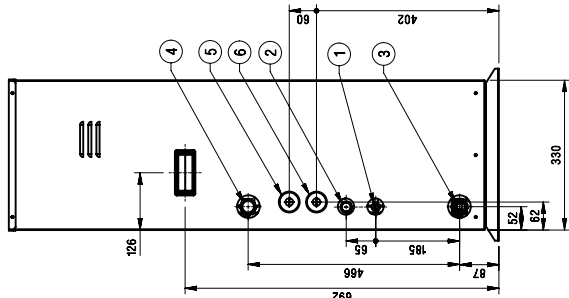

Note

1. Unit should be installed in compliance with the installation manual in the product box.
2. Unit should be grounded in accordance with the local regulations or applicable national codes.
3. All electrical components and materials to be supplied from the site must comply with the local regulations or international codes.

No.	Part Name	Description
6	Power Supply Cable	∅ 30
5	Communication Cable	∅ 30
4	Water Outlet	-
3	Water Inlet	-
2	Gas Pipe	-
1	Liquid Pipe	-

[Unit: mm]

4. Piping Diagrams

ARNH08GK3A2 (High Temperature)

As is Hydro Kit (For High Temperature), there are three different fluids cycling inside the system : one is R134a refrigerant, the other R410A refrigerant, another is water. These cycles are shown below.

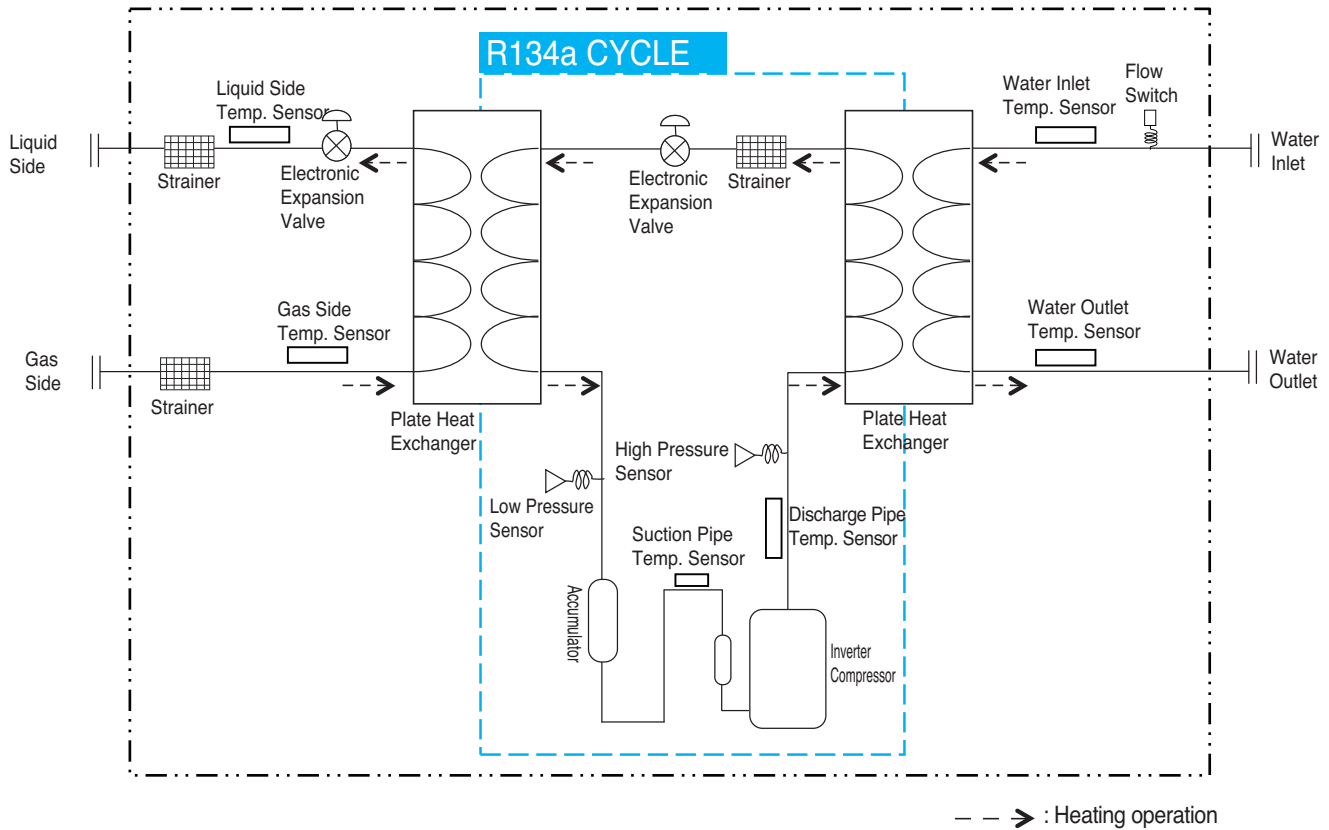

Description	PCB Connector		Remarks
Air Temperature Sensor	Main PCB	CN_ROOM	- Optional Accessory (being sole separately) - Not shown in diagram
Liquid side Temperature Sensor		CN_PIPE/IN	
Gas side Temperature Sensor		CN_PIPE/OUT	
Water Inlet Temperature Sensor		CN_TH3	- Water Inlet and Water Outlet sensors connected to 4 pin type connector CN_TH3 (Black)
Water Outlet Temperature Sensor			
Suction Pipe Temperature Sensor	Inverter PCB	CN_TH3	- Suction Pipe and Discharge Pipe sensors connected to 4 pin type connector CN_TH3 (Red)
Discharge Pipe Temperature Sensor			
Inside Air Temperature Sensor		CN_TH2	- Not shown in diagram

6. Capacity correction factor

6.1 Capacity correction factor by temperature

ARNH08GK3A2 (Heating)

Hydro Kit (High Temp.)

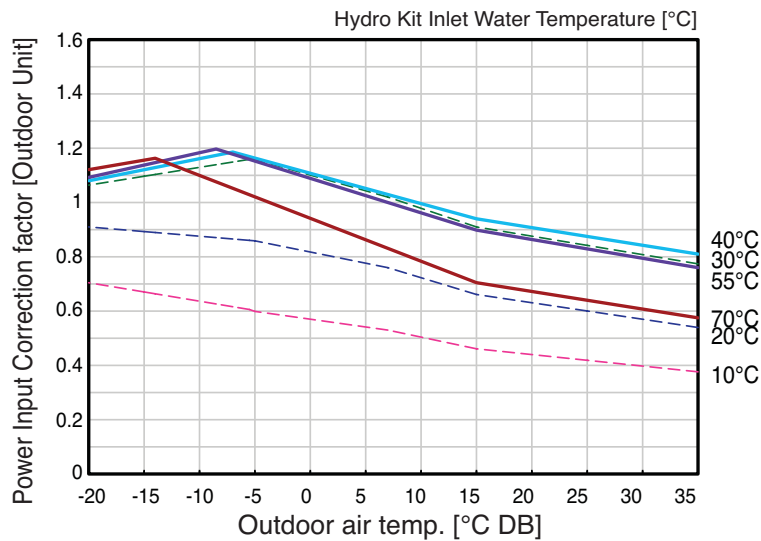
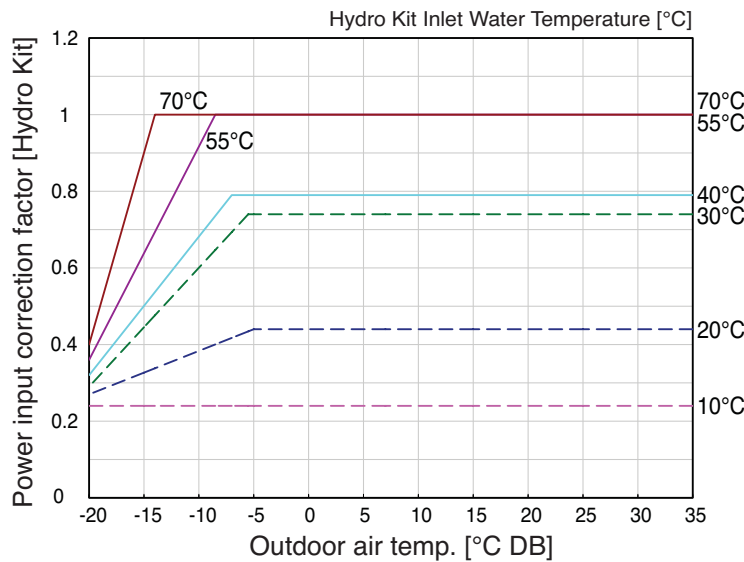
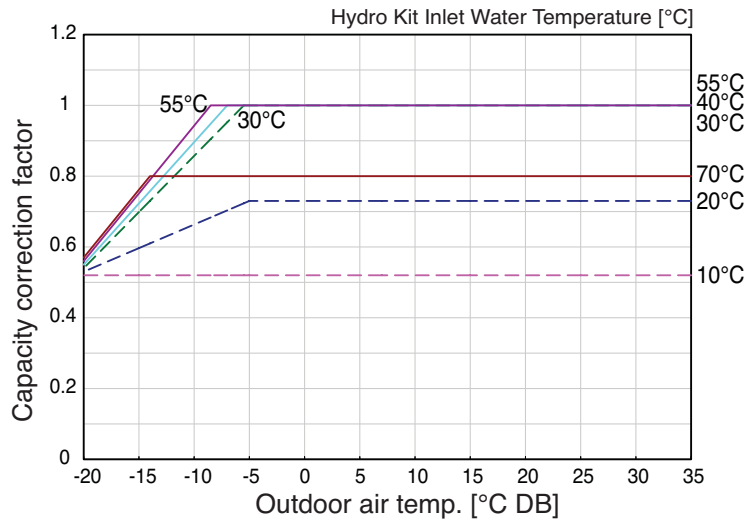

6. Capacity correction factor

6.2 Capacity correction factor by water flow rate

ARNH08GK3A2 (Heating)

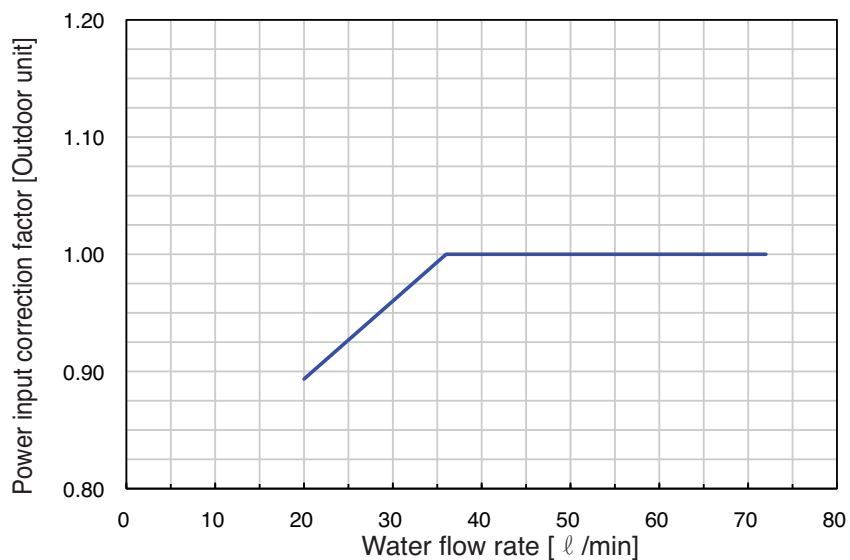
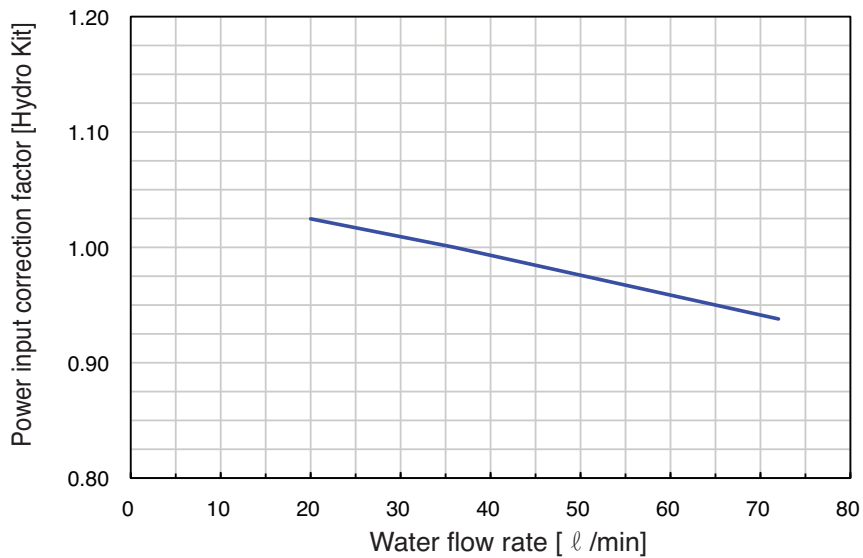
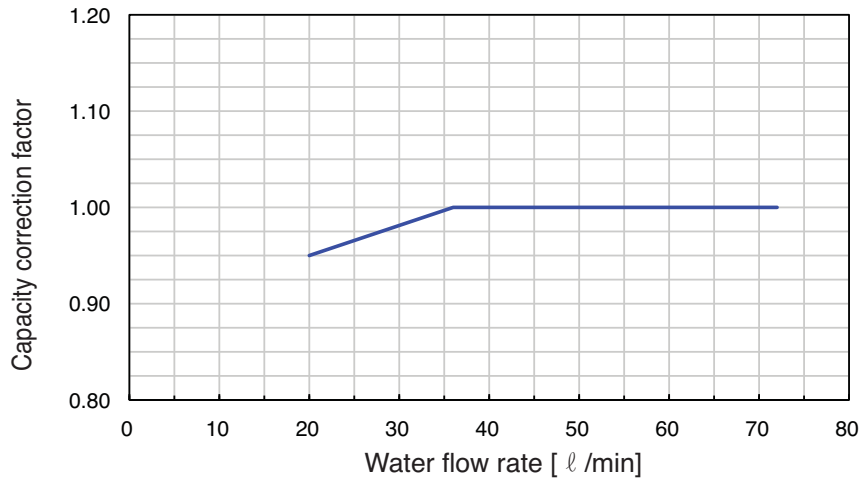

6. Capacity correction factor

6.3 Capacity correction factor by combination ratio

ARNH08GK3A2

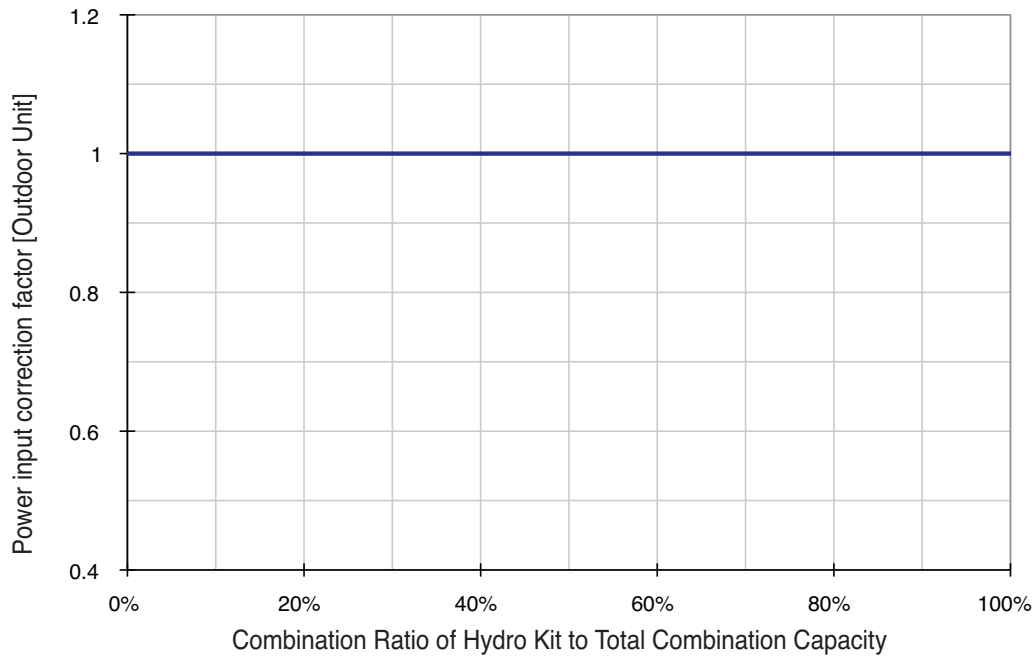
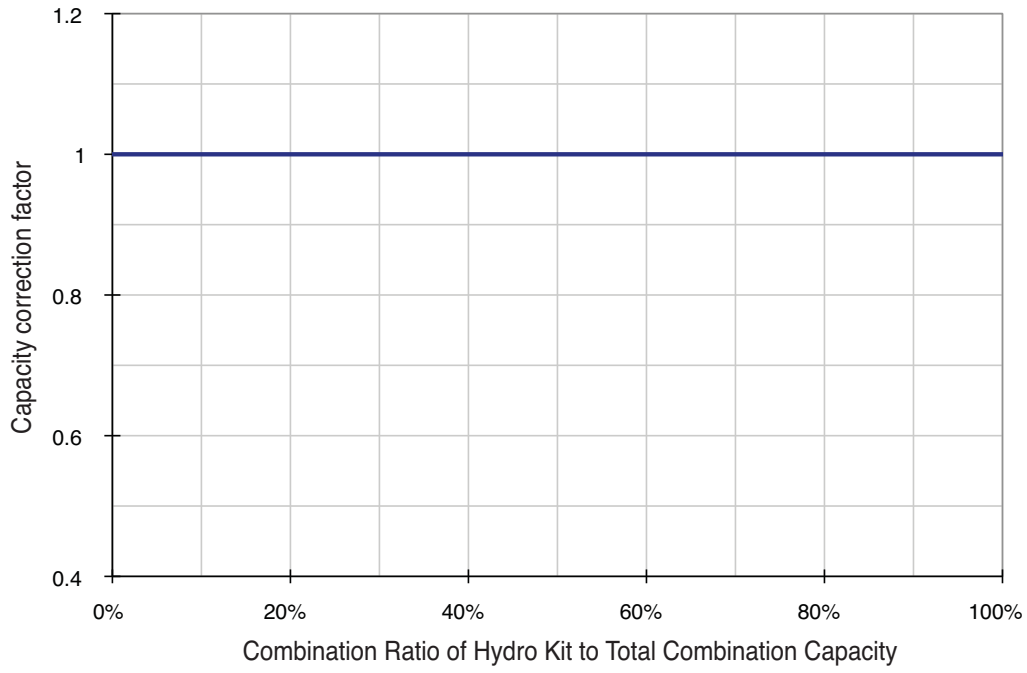

6. Capacity correction factor

6.4 Capacity correction factor by defrosting operation

The capacity table does not consider reduction in capacity when frost has accumulated or during defrosting. The capacity values considered these factors, in other words the integrated heating capacity values, can be obtained as follows:

Formula

Integrated Heating capacity = A

Value given in table of capacity characteristics = B

Integrated correction factor for frost accumulation = C

$A=B \times C$

Correction factor for finding integrated Heating capacity

Inlet Port Temperature of Heat Exchange (*C/RH 85%)	-7	-5	-3	0	3	5	7
Integrated Correction Factor for Frost Accumulation (Normal Defrost Operation)	0.98	0.95	0.93	0.86	0.93	0.96	1.0
Integrated Correction Factor for Frost Accumulation (Partial Defrost Operation)	0.98	0.95	0.93	0.91	0.95	0.97	1.0

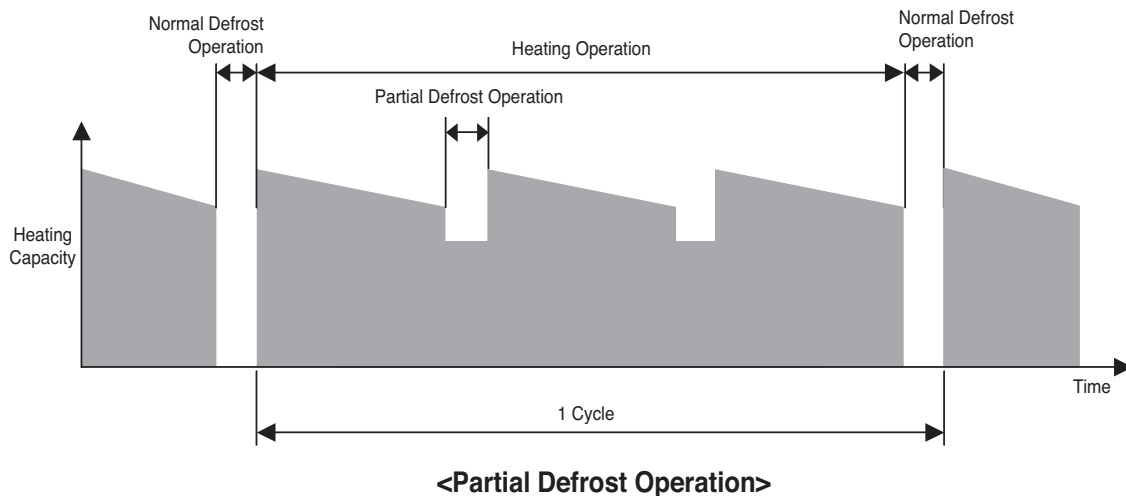
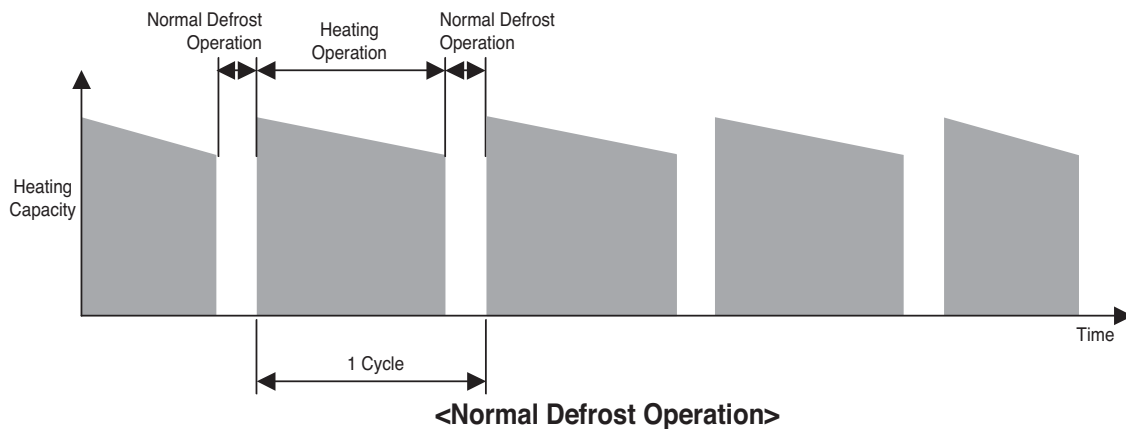

Please note that there will be temporary reduction in capacity when snow piles up on the outside surface of the outdoor unit heat exchanger. Of course, it will be different in degree depending on a number of other factors, for example, the outdoor temperature(°CDB), the relative humidity(RH) and the frosting amount.

7. Water Pressure Drop

ARNH08GK3A2

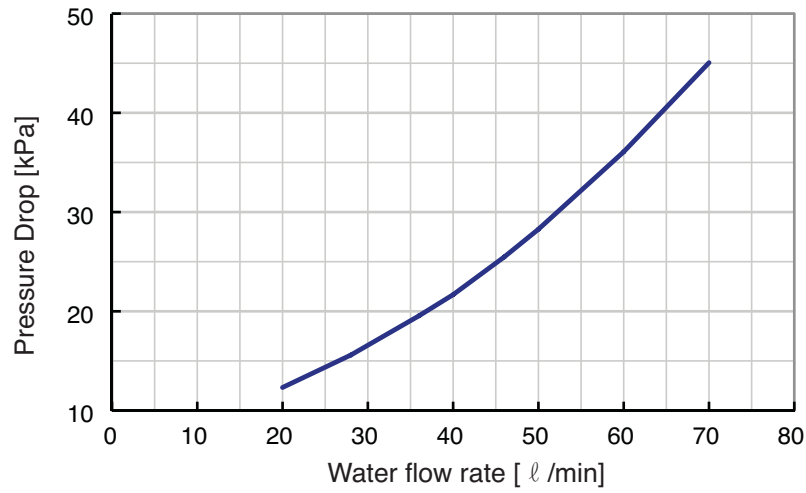

8. Operation Limits

ARNH08GK3A2 (Heating)

ARUN- series

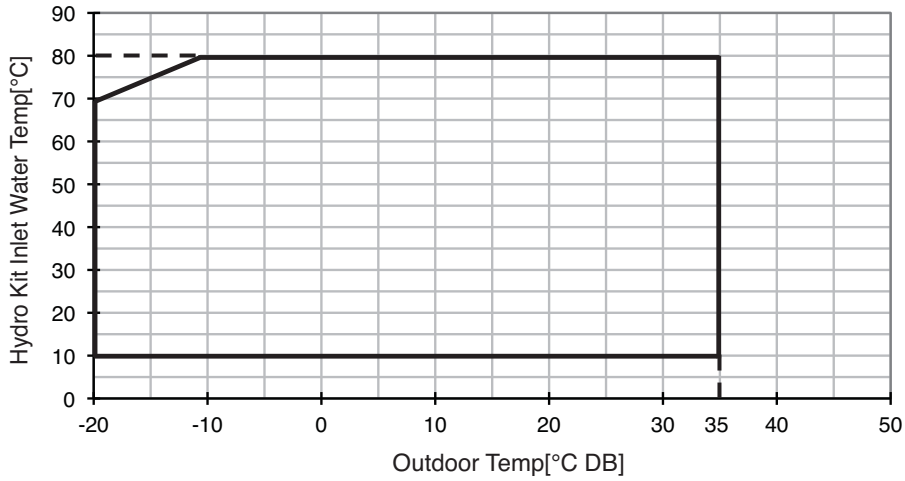

ARUB- series

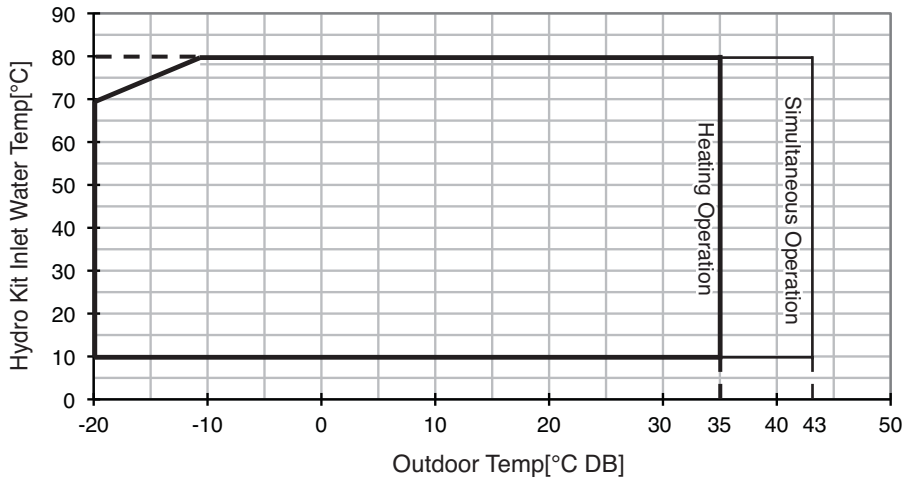

ARWB- series, ARWN-series

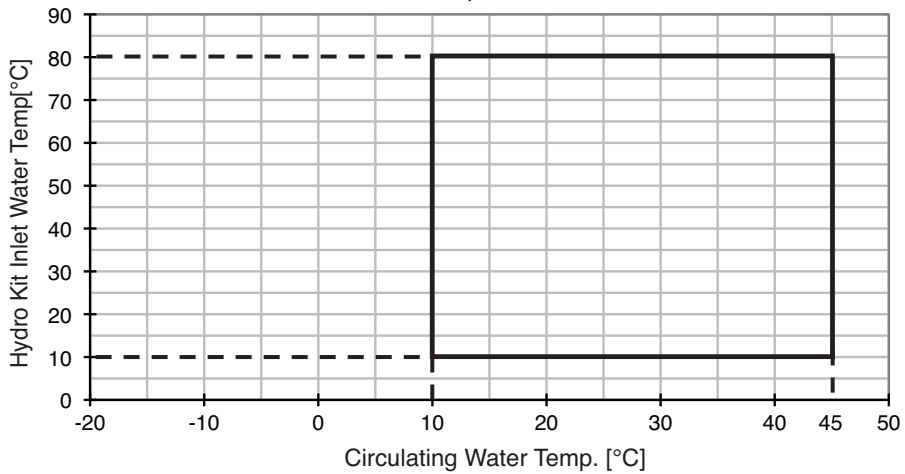

Notes

'Simultaneous Operation' means other Indoor units are operating on cooling mode.

9. Electric Characteristics

Wiring of Main Power Supply and Equipment Capacity

1. Separate power supply lines for the indoor units from outdoor unit..
2. Bear in mind ambient conditions (ambient temperature,direct sunlight, rain water,etc.) when proceeding with the wiring and connections.
3. The wire size is the minimum value for metal conduit wiring. The power cord size should be 1 rank thicker taking into account the line voltage drops. Make sure the power-supply voltage does not drop more than 10%.
4. Specific wiring requirements should adhere to the wiring regulations of the region.
5. Power supply cords of parts of appliances for outdoor use should not be lighter than polychloroprene sheathed flexible cord.
6. Don't install an individual switch or electrical outlet to disconnect each of indoor unit separately from the power supply.



WARNING

- Follow ordinance of your governmental organization for technical standard related to electrical equipment, wiring regulations and guidance of each electric power company.
- Make sure to use specified wires for connections so that no external force is imparted to terminal connections. If connections are not fixed firmly, it may cause heating or fire.
- Make sure to use the appropriate type of overcurrent protection switch. Note that generated overcurrent may include some amount of direct current.



CAUTION

- Some installation site may require attachment of an earth leakage breaker. If no earth leakage breaker is installed, it may cause an electric shock.
- Do not use anything other than breaker and fuse with correct capacity. Using fuse and wire or copper wire with too large capacity may cause a malfunction of unit or fire.

ARNH08GK3A2

Model	Type	Hz	Volts	Voltage Range	Power Supply			Input(W)	
					MCA(A)	TOCA(A)	MFA(A)	MSC(A)	RLA(A)
ARNH08GK3A2	K3	50	220-240	Max:264 Min:198	26.4	27	30	-	23.0
	K3	60	220	Max:242 Min:198	26.4	27	30	-	23.0

Symbols:

- MCA : Minimum Circuit Amperes (A)
- MFA : Maximum Fuse Amperes
- TOCA : Total Over Current Amperes (A)
- MSC : Maximum Starting Current (A)
- RLA : Rated Load Amperes (A)

10. Sound Levels

10.1 Sound Pressure Level

Overall

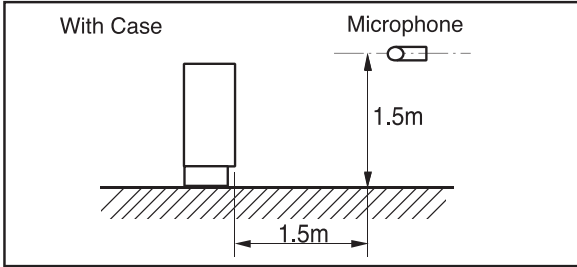

Notes:

- Sound measured at 1.5m away from the center of the unit.
- Data is valid at free field condition
- Data is valid at nominal operating condition
- Reference acoustic pressure 0dB = 20μPa
- Sound level will vary depending on a range of factors such as the construction(acoustic absorption coefficient) of particular room in which the equipment is installed.

Model	Sound Pressure Level (dB(A))
ARNH08GK3A2	43

ARNH08GK3A2

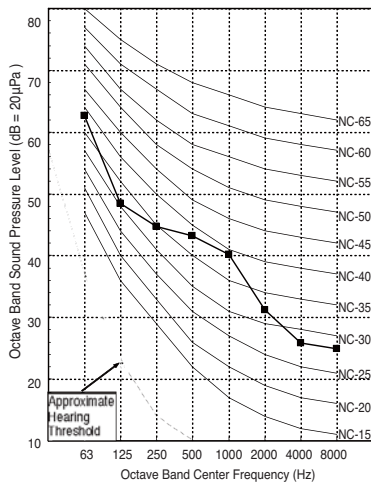

10.2 Sound Power Level (Reference Data)

Model	Sound Power Level (dB(A))
ARNH08GK3A2	28.5

Notes:

- Data is valid at nominal operating condition
- Reference acoustic intensity 0dB = 10E-6μW/m²

11. Installation

11.1 Transporting the Unit

- When carrying the suspended unit, pass the ropes between legs of base panel under the unit.
- Always lift the unit with ropes attached at four points so that impact is not applied to the unit.
- Attach the ropes to the unit at an angle (A) of 40° or less.
- Use only accessories and parts which are of the designated specification when installing.

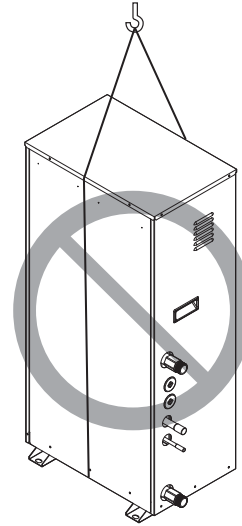
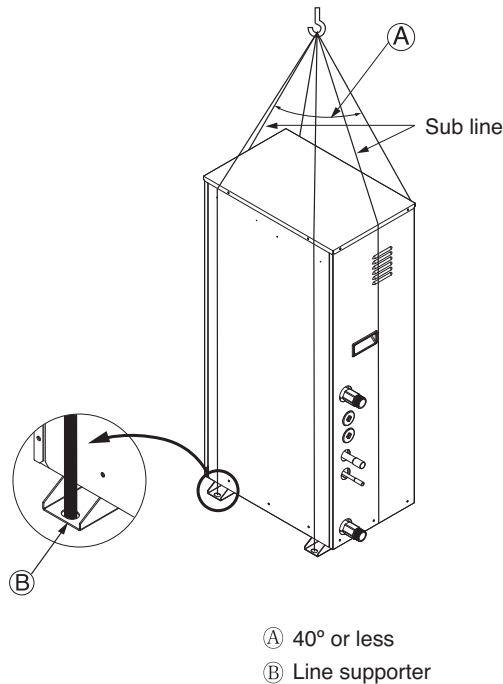

CAUTION

Be very careful while carrying the unit.

- Do not have only one person carry the unit if it is more than 20 kg (44.1 lbs).
- PP bands are used to pack some products. Do not use them as a mean for transportation because they are dangerous.
- Tear plastic packaging bag and scrap it so that children cannot play with it. Otherwise plastic packaging bag may suffocate children to death.
- When carrying the unit, be sure to support it at 4-points. Carrying and lifting the unit with 3-point support may make it unstable, resulting in a fall.

11. Installation

11.2 Selection of the best location

Select space for installing the unit, which will meet the following conditions:

- The place where the unit shall be installed inside.
- The place shall easily bear a load exceeding four times of the unit weight.
- The place where the unit shall be leveled.
- The place shall allow easy water drainage.
- The place where the unit shall be connected to the outdoor unit.
- The place where the unit is not affected by an electrical noise.
- The place where there should not be any heat source or steam near the unit.

Installation Space

- The following values are the least space for installation.
If any service area is needed for service according to field circumstance, obtain enough service space.
- The unit of values is mm.

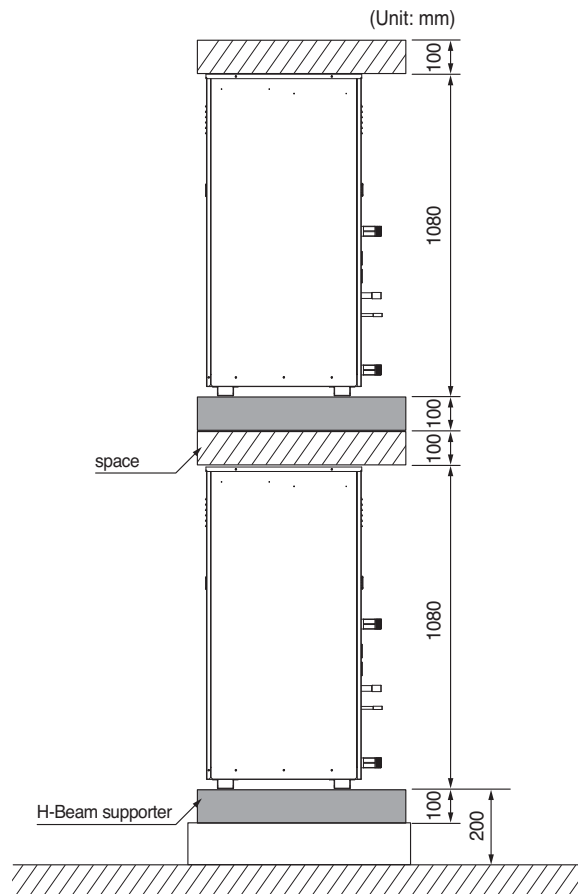
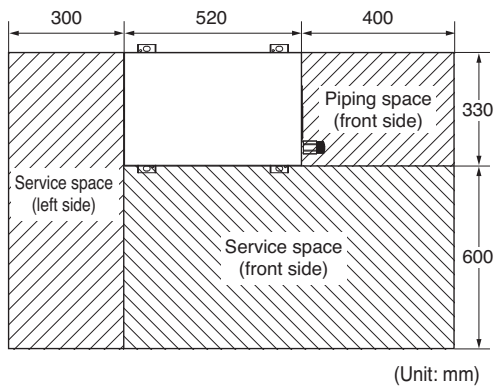

11. Installation

Foundation for Installation

- Fix the unit tightly with bolts as shown below so that the unit will not fall down due to earthquake.
- Noise and vibration may occur from the floor or wall since vibration is transferred through the installation part depending on installation status.

Thus, use anti-vibration materials (cushion pad) fully (The base pad shall be more than 200 mm (7-7/8 inch)).

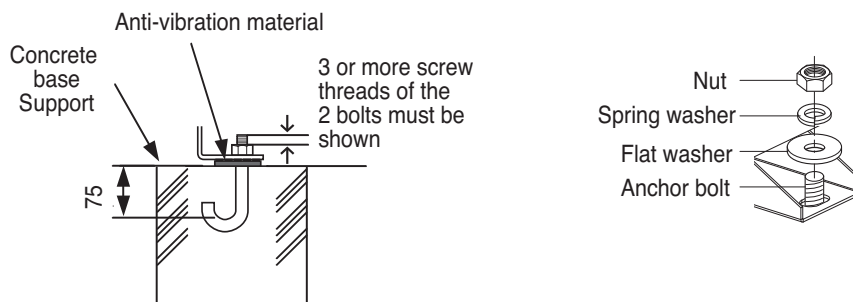

11.3 Water Piping and Water Circuit Connection

General Considerations

Followings should be considered before beginning water circuit connection.

- Service space should be secured.
- Water pipes and connections should be cleaned using water.
- Space for installing external water pump should be provided.
- Never connect electric power while proceeding water charging.

Water Piping and Water Circuit Connection

While installing water pipes, followings should be considered :

- While inserting or putting water pipes, close the end of the pipe with pipe cap to avoid dust entering.
- When cutting or welding the pipe, always be careful that inner section of the pipe should not be defective. For example, no weldments or no burrs are found inside the pipe.
- Pipe fittings (e.g. L-shape elbow, T-shape tee, diameter reducer, etc) should be tightened strongly to be free from water leakage.
- Connected sections should be leakage-proof treatment by applying tefron tape, rubber bushing, sealant solution, etc.
- Appropriate tools and tooling methods should be applied to prevent mechanical breakage of the connections.
- Operation time of flow valve(e.g. 3way valve) should be less than 90 seconds.
- Pipe is insulated to prevent heat loss to external environment.

11. Installation

11.3.1 Water cycle

* For the water pipe system, use the closed loop type.

1. For the parts of the water pipe system, use the parts above the design water pressure.
2. For the water pipe, do not use steel pipe.
3. To replace the connected device easily, install the union joint (2).
4. Install the service port (3) to clean the heat exchanger at each inlet and outlet of the water pipe.
5. Always install a strainer (4) at the inlet of the water pipe.
 - For the strainer, use one with 50 mesh or above with measurement diameter of 0.4mm or less. (Exclude other net)
 - Always install the strainer on the horizontal pipe.
(When dirt, trash, rusted pieces get into the water pipe system, it can cause problems to the product by corroding the metallic material.)
6. Install the air vent (5) at the top of the water pipe.
7. Install a thermometer (6) and pressure gauge (7) at the inlet and outlet of the water pipe.
8. Install the drain valve (8) that can be used for draining the water inside when replacing the part or providing service.
9. Install the shut-off valve (9) to block the water by closing the valve when replacing the part or cleaning.
10. Apply insulated treatment on the exterior of the water pipe so that water drops do not form.
11. Install excessive pressure safety valve (10) that meets the design water pressure to prevent unit or water pipe damage at the pressure increase inside the water pipe system.

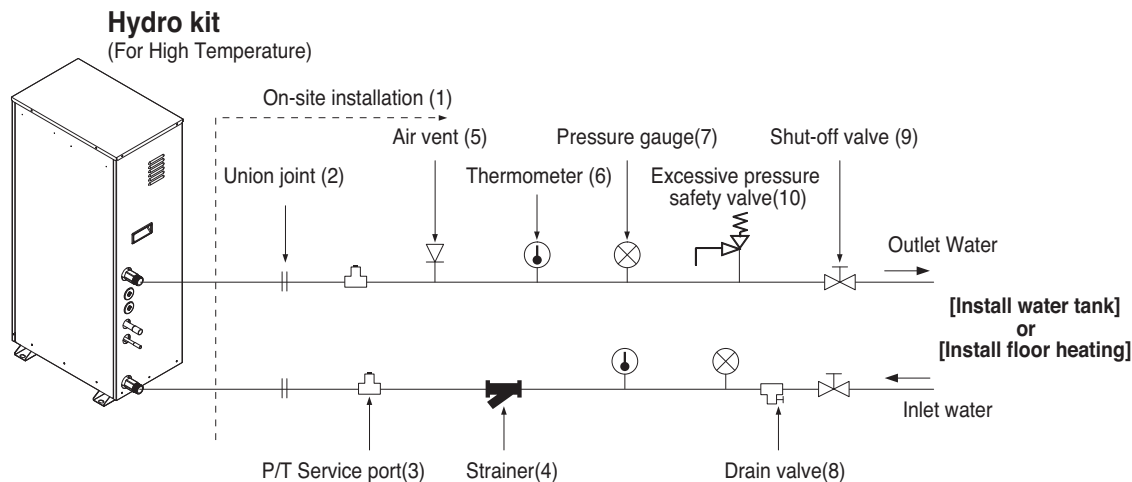

12. There is a drain hole at the bottom of the Hydro Kit to prevent risk of electric shock caused by leakage of water.

11. Installation

11.3.2 Water tank & Floor heating installation

1. Use the pump (1) with sufficient capacity to assure loss of overall water pressure and to supply water to the **Hydro Kit**.
2. Install the shut-off valve (2) on both sides of the pump to clean and repair the pump.
3. Install the flexible joint (3) to prevent noise and vibration transferred from the pump.
4. Install the pressure gauge (4) to monitor the water pressure from water tank. (Option)
5. Install the expansion tank (5) to accommodate the water contracted or expanded from the temperature difference and to supply the water.
6. After the installation of water pipe system is completed, open the water supply valve (6) and supply the water.
7. When installing the water tank, insert the water tank temperature sensor (7) to measure the temperature of the water inside the tank.
 - For the water tank temperature sensor, use the sensor supplied on the product.
 - When heating the floor, measure the temperature by using the remote controller or remote temperature sensor (Separately sold).
8. Use the water tank (9) with the heat exchange coil (8) installed so that the heat can be exchanged sufficiently inside the tank.

* Installation of water tank

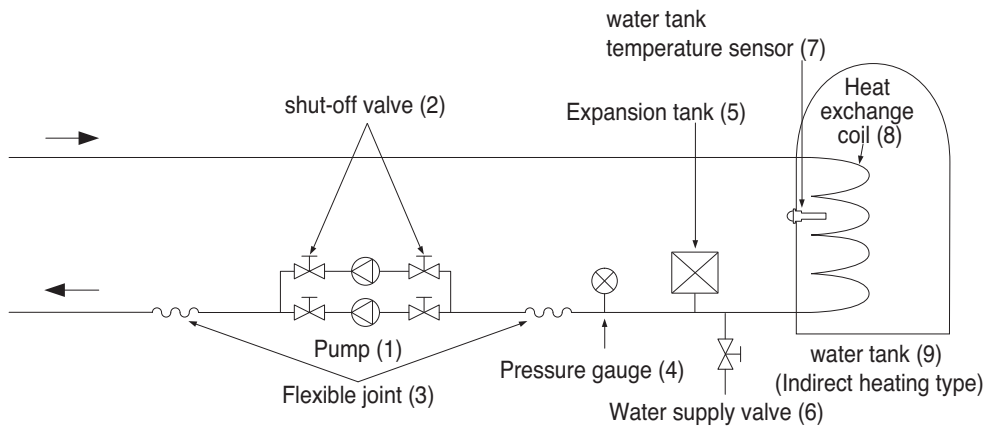

* Installation of floor heating

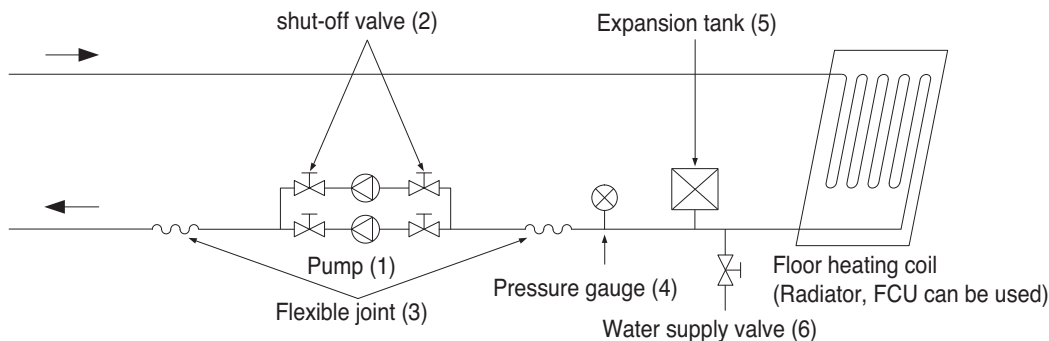

11. Installation

11.3.3 Strainer

- Use the 50 mesh strainer.
(Exclude scale diameter of 0.4mm or less and other net)
- Check the strainer direction and assemble on the inlet hole (Refer to picture)
- Wrap the Teflon tape on the screw thread of the water pipe for more than 15 times for assembly.
- Install the service port facing downward. (Within left/right 45 degrees)
- Check if there is any leakage on the connecting part.
- Clean the strainer periodically. (Once a year or more frequent)

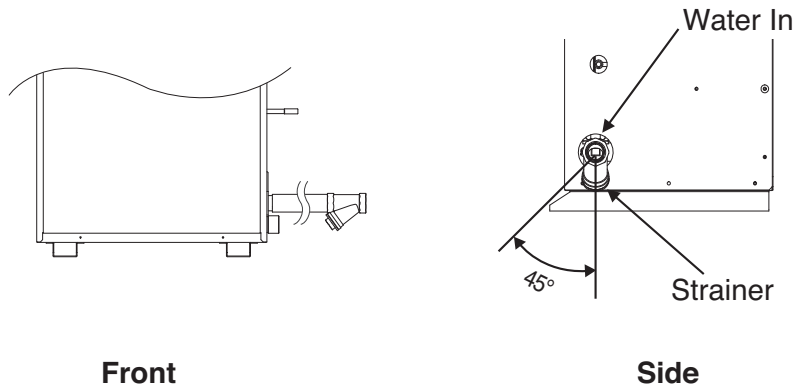

11. Installation

11.4 Sanitary Water Tank and Sanitary Water Tank Kit

11.4.1 Installation Condition

Installing sanitary water tank requires following considerations :

- Sanitary water tank should be located at the flat place.
- Water quality should comply with EN 98/83 EC Directives.
- As this water tank is sanitary water tank (indirect heat exchange), do not use anti water-freezing treatment like ethylene glycol.
- It is highly recommend to wash out inside of the sanitary water tank after installation. It ensures generating clean hot water.
- Near the sanitary water tank, there should be water supply and water drain for easy access and maintenance.

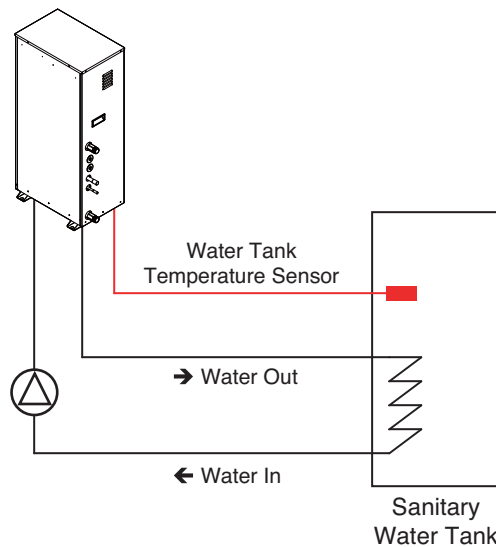

11.4.2 Water tank temperature sensor connection

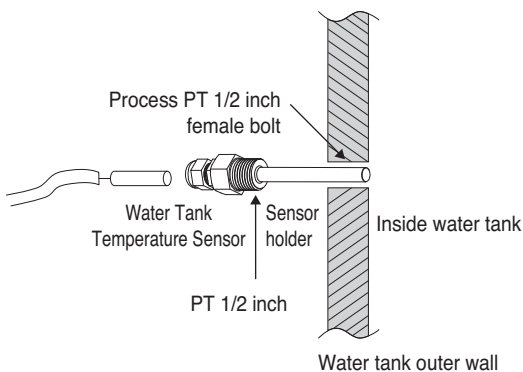

- If hot water mode is used, make sure to install sensor to water tank.
- Make PT15A female bolt hole in the water tank, and install sensor in the water tank.
- Push the sensor into the hole of the sensor holder cap.
- Lock the sensor holder cap.

11. Installation



WARNING :

Installing recirculation pump

When Hydro Kit is used with the sanitary water tank, it is **STRONGLY** recommended to install recirculation pump to prevent cold water at the end of hot water supply flooding out and to stabilize the water temperature inside the sanitary water tank.

- The recirculation pump should be operated when sanitary water demand is not required. Therefore, external time scheduler to determine when the recirculation pump should turn on and turn off is required.

- The operating duration time of the recirculation pump is calculated as follow :

$$\text{Duration time [minute]} = k * V / R$$

k : 1.2 ~ 1.5 is recommended.

(If distance between pump and tank is far, then choose high number.)

V : Volume of sanitary water tank [liter]

R : Water flow rate of pump [liter per minute], which is determined by pump performance curve.

- The pump operating start time should be prior to the sanitary water demand.

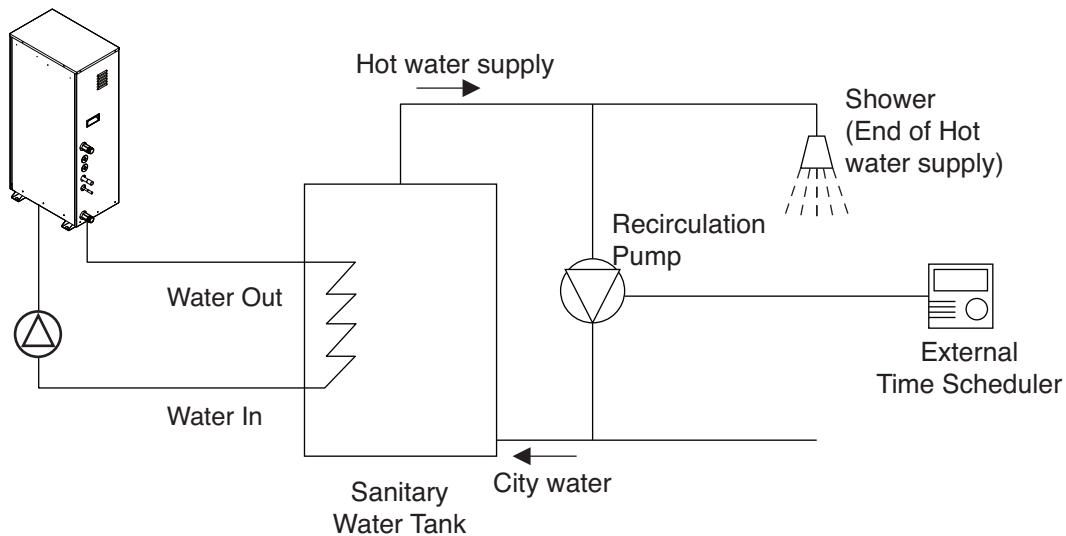

11. Installation

11.4.3 How to design the heat exchange coil inside water tank (Example)

*** General water heat exchange coil calculation**

$$Q = U \times A [t_s - (t_2 + t_1 / 2)]$$

Q: Heat exchange amount (kcal/hr)

U: Overall heat transfer coefficient (kcal/m²hr°C)

A: Heating area (m²)

T₁: Inlet temperature of heat source water (°C)

T₂: Outlet temperature of heat source water (°C)

T_s: Water temperature inside water tank
(Target temperature) (°C)

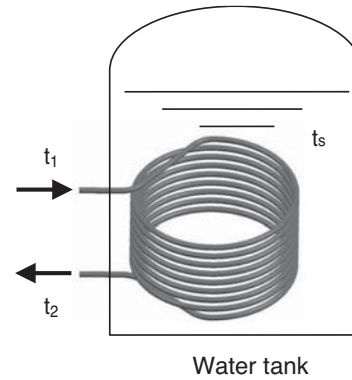

[Example] 32kW (=27520kcal/hr) heat exchanger calculation

If outer diameter of coil is 22mm

Coil length = A/(3.14 x 0.022)

= About 32m

Design the clearance between coils at 20mm
or above to secure heat exchange area

16 rotations by designing the diameter to 650mm

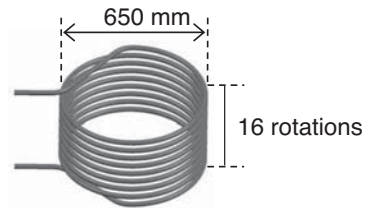

[Example] 32kW heat
exchanger coil
(For outer coil diameter
of 22mm)



CAUTION

- Design of the heat exchange coil inside the water tank can differ by the shape and condition of the water tank.

11. Installation

11.5 Installation Scenes

Some installation scenes are presented for example. As these scenes are conceptual figures, installer should optimize the installation scene according to the installation conditions.

1) Floor Heating only

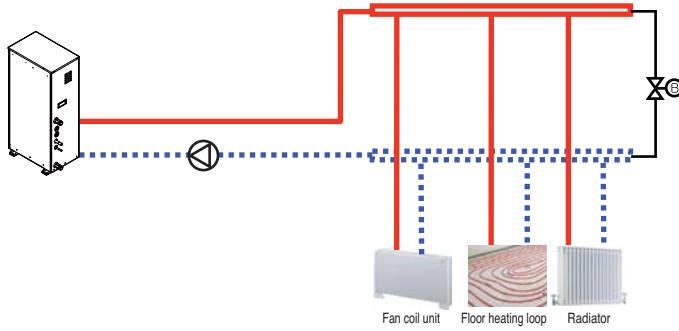

2) Floor Heating + Hot water

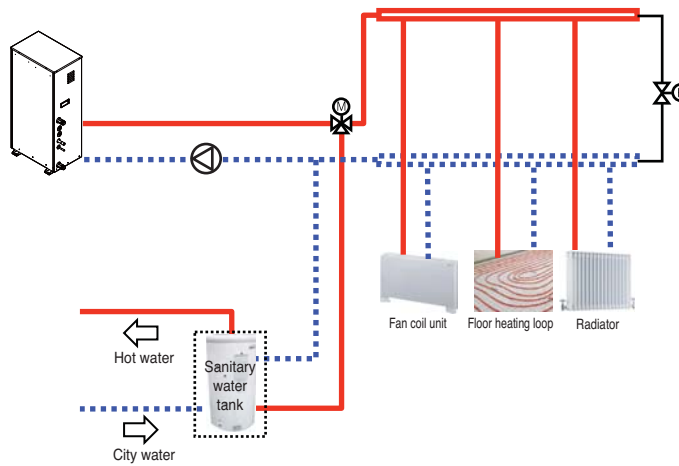

3) Hot water only

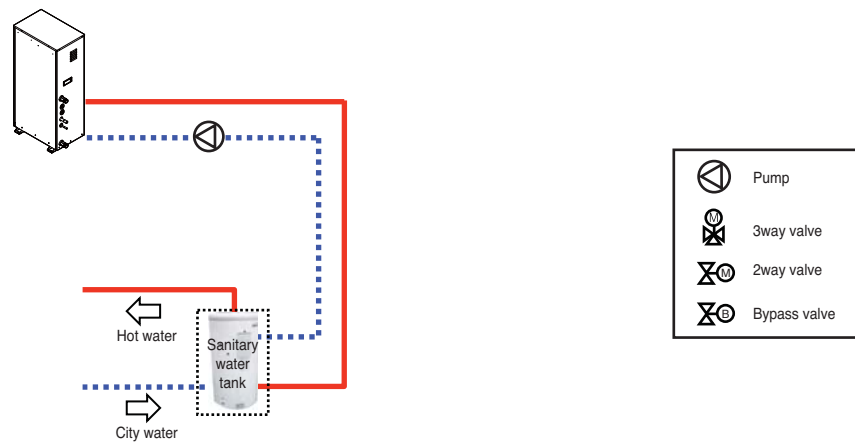

Hydro Kit (High Temp.)

11. Installation

11.6 Water Quality

Water quality should comply with EN 98/83 EC Directives. Requirement for resolved chemical ingredients is following table. Detailed water quality condition can be found in EN 98/83 EC Directives.

Parameter	Value	Parameter	Value
Acrylamide	0.10 µg/l	Fluoride	1.5 mg/l
Antimony	5.0 µg/l	Lead	10 µg/l
Arsenic	10 µg/l	Mercury	1.0 µg/l
Benzene	1.0 µg/l	Nickel	20 µg/l
Benzo(a)pyrene	0.010 µg/l	Nitrate	50 mg/l
Boron	1.0 mg/l	Nitrite	0.50 mg/l
Bromate	10 µg/l	Pesticides	0.10 µg/l
Cadmium	5.0 µg/l	Pesticides — Total	0.50 µg/l
Chromium	50 µg/l	Polycyclic aromatic hydrocarbons	0.10 µg/l
Copper	2.0 mg/l	Selenium	10 µg/l
Cyanide	50 µg/l	Tetrachloroethene and Trichloroethene	10 µg/l
1,2-dichloroethane	3.0 µg/l	Trihalomethanes — Total	100 µg/l
Epichlorohydrin	0.10 µg/l	Vinyl chloride	0.50 µg/l

CAUTION

- If the unit is installed at existing hydraulic water loop, it is important to clean hydraulic pipes to remove sludge and scale.
- Installing sludge strainer in the water loop is very important to prevent performance degrade.
- Chemical treatment to prevent rust should be performed by installer.

Frost protection

In areas of the country where entering water temperatures drop below 0°C(32°F), the water pipe must be protected by using an approved antifreeze solution. Consult your **Hydro Kit** unit supplier for locally approved solutions in your area. Calculate the approximate volume of water in the system. (Except the **Hydro Kit** unit.) And add antifreeze solution to the total volume to allow for the water contained in **Hydro Kit** unit.

Type of Antifreeze	Minimum Temperature for Freeze Protection					
	0°C(32°F)	-5°C(23°F)	-10°C(14°F)	-15°C(5°F)	-20°C(-4°F)	-25°C(-13°F)
Ethylene glycol	0%	12%	20%	30%	-	-
Propylene glycol	0%	17%	25%	33%	-	-
Methanol	0%	6%	12%	16%	24%	30%

CAUTION

1. Use only one of the above antifreeze.
2. If a antifreeze is used, pressure drop and capability degradation of the system can occur.
3. If one of antifreezes is used, corrosion can occur. So please add corrosion inhibitor.
4. Please check the concentration of the antifreeze periodically to keep same concentration.
5. When the antifreeze is used (for installation or operation), take care to ensure that antifreeze must not be touched.
6. Ensure to respect all laws and norms of your country about Anti-freeze usage.

11. Installation

11.7 Refrigerant Piping

Water quality should comply with EN 98/83 EC Directives. Requirement for resolved chemical ingredients is following table. Detailed water quality condition can be found in EN 98/83 EC Directives.

Cut the pipes and the cable

- Use the accessory piping kit or the pipes purchased locally.
- Measure the distance between the indoor and the outdoor unit.
- Cut the pipes a little longer than measured distance.
- Cut the cable 1.5m longer than the pipe length.

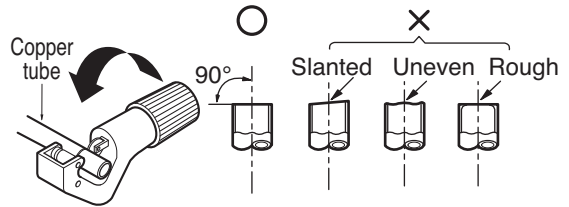

Burrs removal

- Completely remove all burrs from the cut cross section of pipe/tube.
- Put the end of the copper tube/pipe to downward direction as you remove burrs in order to avoid to let burrs drop in the tubing.

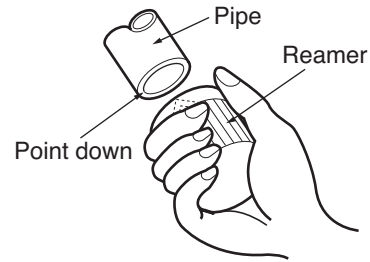

Pipe welding

- Insert and weld the pipe.
- Always make sure to flow Nitrogen at 0.2kgf/cm² within the pipe when welding.
- If the welding is done without flowing Nitrogen, it can generate a thick oxidized coating within the pipe to interfere with normal operation of valve and compressor etc.

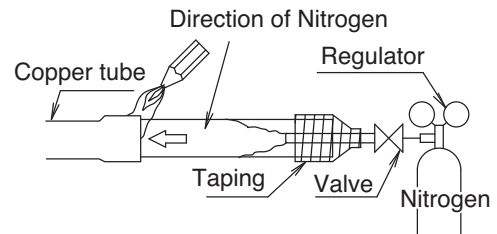

Insulation

- Use rubber foamed insulation material (EPDM, NBR) with high thermal resistance.
- When installed in humid environment, use thicker insulation material than usual.
- Insert the insulation material within the product as deep as possible.

* The thickness of the above insulation material is based on thermal conduction rate of 0.036W/m °C.

Classification	Thickness
Liquid pipe(Ø9.52)	t9 or above
Gas pipe(Ø22.2)	t19 or above

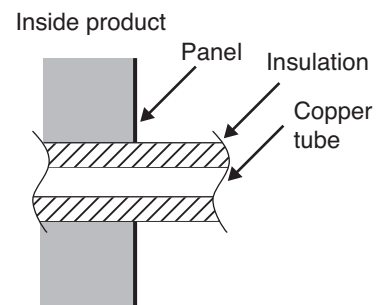

CAUTION

There is no pump-down function because Hydro Kit is the only heating unit. After vacuum drying, recharge the refrigerant.

11. Installation

Precaution when connecting Heat Recovery systems

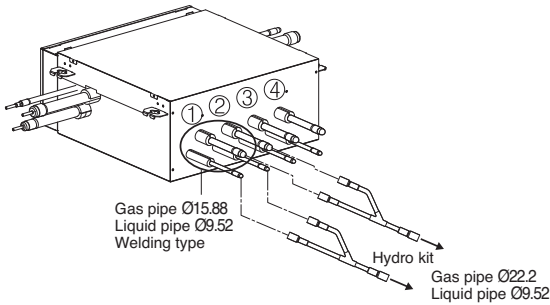

Precaution when connecting to synchronous type outdoor unit

- One connection of refrigerant pipe for HR unit is insufficient for the flow of refrigerant. Join two pipes with a branch pipe when connecting the **Hydro Kit**.
- The pipe number of the connected gas pipe and liquid pipe must be same.
- Do not flow water in the **Hydro Kit** when pipe-searching process is performed.
- Pipe-searching process error may occur if the pipe temperature does not increase.
- It is recommended that **Hydro Kit** is connected to No.1 valve and No.2 valve.

	DIP S/W setting	Example
Not control		
No.1, 2 Valve Control		
No.2, 3 Valve Control		
No.3, 4 Valve Control		
No.1, 2 Valve / No.3, 4 Valve Control		

Auto-Piping process

1. When Auto-Piping process is performed,
 - Use 'Mode 1' if water temperature is higher than 30°C(86°F)
 - Use 'Mode 2' if water temperature is lower than 30°C(86°F)
2. When Auto-Piping process is not performed,
 - Check whether 'CH14' error occurs in the **Hydro Kit**.

*Refer to the installation manual of HR unit

11. Installation

11.8 Electrical Wiring

11.8.1 How to connect wirings

Remove the box cover of electric parts and connect the wiring

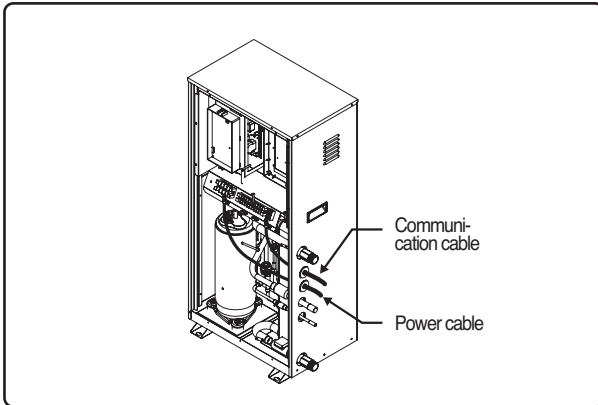

CAUTION

When connecting the power and communication cable, always use the terminal connector (O-ring, Y-ring).

Make sure to tighten so that the screw of the terminal does not get loose.

Connect the wires to the terminals on the control board individually according to the outdoor unit connection.

*Ensure that the wire color of the outdoor unit and terminal No. are same as those of the indoor unit respectively.

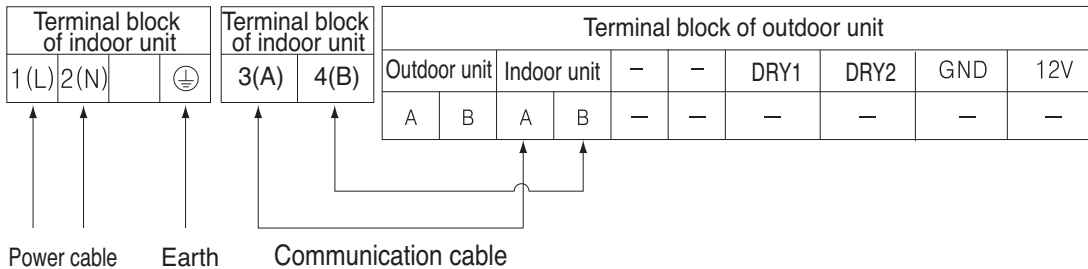

WARNING : Make sure that the screws of the terminal are free from looseness.

CAUTION

After checking the above status, prepare for the following wiring :

- 1) Use individual power for the unit and refer to the circuit diagram posted on the inside of the control cover.
 - 2) Make sure to install 40A capacity circuit breaker when power is connected to the unit.
 - 3) The bolts used for cable connection may become loose by the vibration generated during the transportation. Make sure to check again and fasten them tightly. (If they are loose, it may cause fire.)
 - 4) Make sure to check power specification.
 - 5) Electrical capacity shall be sufficient.
 - 6) The initial voltage shall be maintained at 90% of the rated voltage on the name plate.
 - 7) The thickness of the power cable complies with the designated specification. (length and thickness of the power cable)
 - 8) Do not install the circuit breaker in the place where there is a lot of moisture or where it is wet.
 - 9) The following problems may be the cause of voltage drop.
 - Magnetic switch vibration, defective contact, fuse damage, malfunction of overload protection device
- ※ Based on the owner's manual, teach how to operate and use the unit to the user. (temperature setting, etc.)

Hydro Kit (High Temp.)

11. Installation

11.8.2 Connecting Cables

Types of the cables

Classification	types	Cable cross section
Power cable(CV)	mm ² x cores	4.0 x 3
Communication cable(VCTF-SB)	mm ² x cores	1.0~1.5 x 2

The distance between communication cable and power cable

- If the power cable and communication cable are tied together, system malfunction may occur with electrostatic, electromagnetic combination effect causing the interference signal. If communication cable is connected along with power cable, secure at least 50mm distance between indoor unit power cable and communication cable.

It is the value with the assumption of the length of the parallel cable as 100 m. If it is longer than 100m, it shall be calculated again with proportional to the added length.

If the distortion in the waveform of the power still occurs despite securing the distance, increase the distance.

※ When several power cables are inserted into the transmission line, or tied together, make sure to consider the following issues.

- Power cables and communication cable shall not be in the same transmission line.
- Power cables and communication cable shall not be tied together.



WARNING

- Are all of the indoor units and outdoor units grounded?
- If grounding is not properly done, there is a risk of electric shock. Grounding must be done by a qualified technician.
- Consider the surrounding conditions(surrounding temperature, direct sunlight, rain water, etc.) when wiring the cable.
- The thickness of the power cable is the minimum thickness of metal conductor cable. Use thicker cable considering the voltage drop.

12. Accessories Installation

12.1 Location of Accessories and External Parts Connection

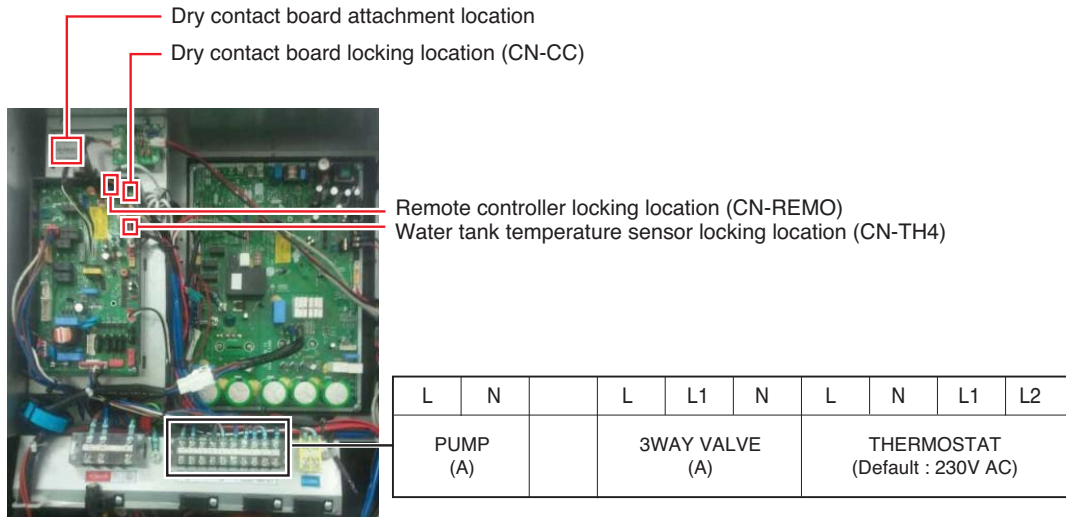

- Connect 3way valve, if both floor heating and hot water is used.
- Connect the separately purchased thermostat.
- Dry contact is an accessory supplied by LG and installed by referring to the attached installation manual.
- 3way valve, thermostat and pump are external parts for installation, which are not supplied by LG. After checking each part carefully, install external parts respectively.
- Connect the cable of each accessory to the terminal block of the control box in the Hydro Kit.
- Check the label attached on the terminal block to prevent wrong connection.
- Use the pump of 220 voltage and maximum operation current of 4A or less.
- Select a suitable relay for pump capacity when connecting the pump to the unit.



WARNING:

- Install the unit after turning off the main power.
- Do not connect the products out of range specified in the manual.
- Do not work with wet hand.

12. Accessories Installation

12.2 Installation of Wired Remote Controller

1. Please fix tightly using provided screw after placing remote controller setup board on the place where you like to setup.

- Please set it up not to bend because poor setup could take place if setup board bends.
- Please set up remote controller board fit to the reclamation box if there is a reclamation box.

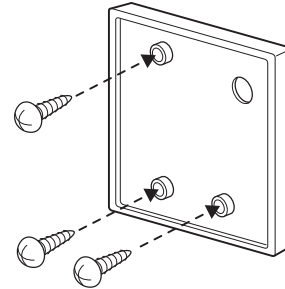

2. Can set up Wired remote controller cable into three directions.

- Setup direction: the surface of wall reclamation, upper, right
- If setting up remote controller cable into upper and right side, please set up after removing remote controller cable guide groove.

* Remove guide groove with long nose.

- ① Reclamation to the surface of the wall
- ② Upper part guide groove
- ③ Right part guide groove

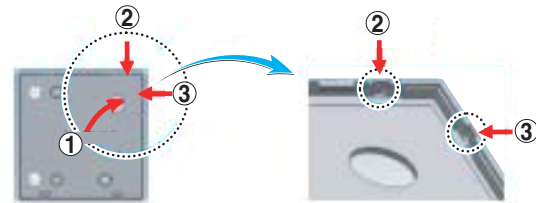

<Wire guide grooves>

3. Please fix remote controller upper part into the setup board attached to the surface of the wall, as the picture below, and then, connect with setup board by pressing lower part.

- Please connect not to make a gap at the remote controller and setup board's upper and lower, right and left part.

<Connecting order>

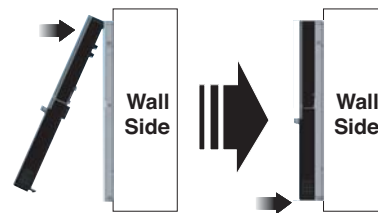

When separating remote controller from setup board, as the picture below, after inserting into the lower separating hole using screw driver and then, spinning clockwise, remote controller is separated.

- There are two separating holes. Please individually separate one at a time.
- Please be careful not to damage the inside components when separating.

<Separating order>

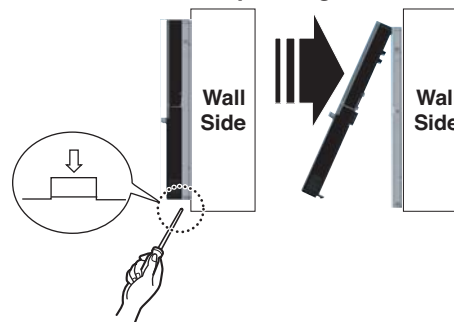

12. Accessories Installation

4. Please connect indoor unit and remote controller using connection cable.

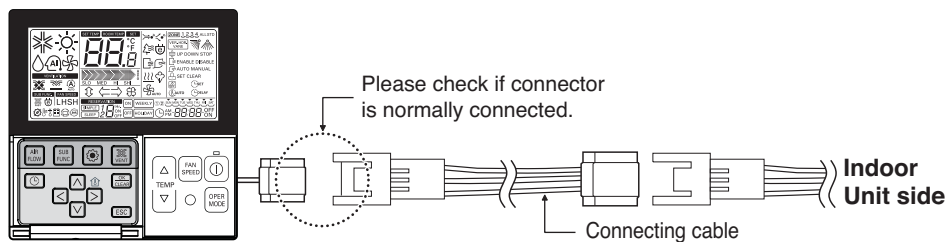

5. Please use extension cable if the distance between wired remote controller and indoor unit is more than 10m.

CAUTION

When installing the wired remote controller, do not bury it in the wall.

(It can cause damage in the temperature sensor.)

Do not install the cable to be 50m or above. (It can cause communication error.)

- When installing the extension cable, check the connecting direction of the connector of the remote controller side and the product side for correct installation.
- If you install the extension cable in the opposite direction, the connector will not be connected.
- Specification of extension cable: 2547 1007 22# 2 core 3 shield 5 or above.

12. Accessories Installation

12.3 Main Pump Connection

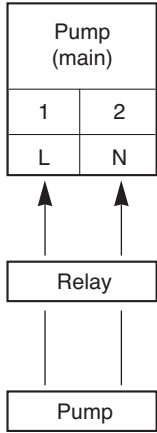

- Select the suitable pump by referring to the flow rate table with water temperature difference between the entrance and the exit.
*It is recommended that the flow rate is 36LPM.
- Use the pump with enough capacity to guarantee the loss of entire water pressure and to supply the Hydro Kit with water.
- Select a suitable relay for pump capacity when connecting the pump to the unit.
- Connect the relay to the terminal block 11 and 12 of the control box.



CAUTION

- Make sure to supply external power with the pump.

12.4 Water tank temperature sensor Connection

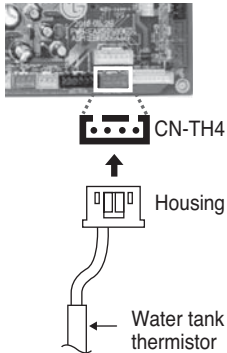

- Connect sensor housing to PCB 'CN-TH4' connector (red).



CAUTION

- If water tank temperature sensor is not connected, error will occur. (CH08) Exclude the case of using floor heating.

12. Accessories Installation

12.5 Thermostat

Thermostat is generally used to control the unit by air temperature. When thermostat is connected to the unit, the unit operation is controlled by the thermostat.

12.5.1 Installation Condition



CAUTION

1. USE 1~230 V Thermostat.
2. Some electro-mechanical type thermostat has internal delay time to protect compressor. In that case, mode change can take time more than user's expectation. Please read thermostat manual carefully if the unit does not respond quickly.
3. Setting temperature range by thermostat can be different with that of the unit. The heating set temperature should be chosen within the setting temperature range of the unit.
4. It is highly recommended that the thermostat should be installed where space heating is mainly applied.

Following location should be avoid to secure proper operation :

- Height from floor is approximately 1.5 m.
- Thermostat can not be located where the area may be hidden when door is open.
- Thermostat can not be located where external thermal influence may be applied. (such as above heating radiator or open window)

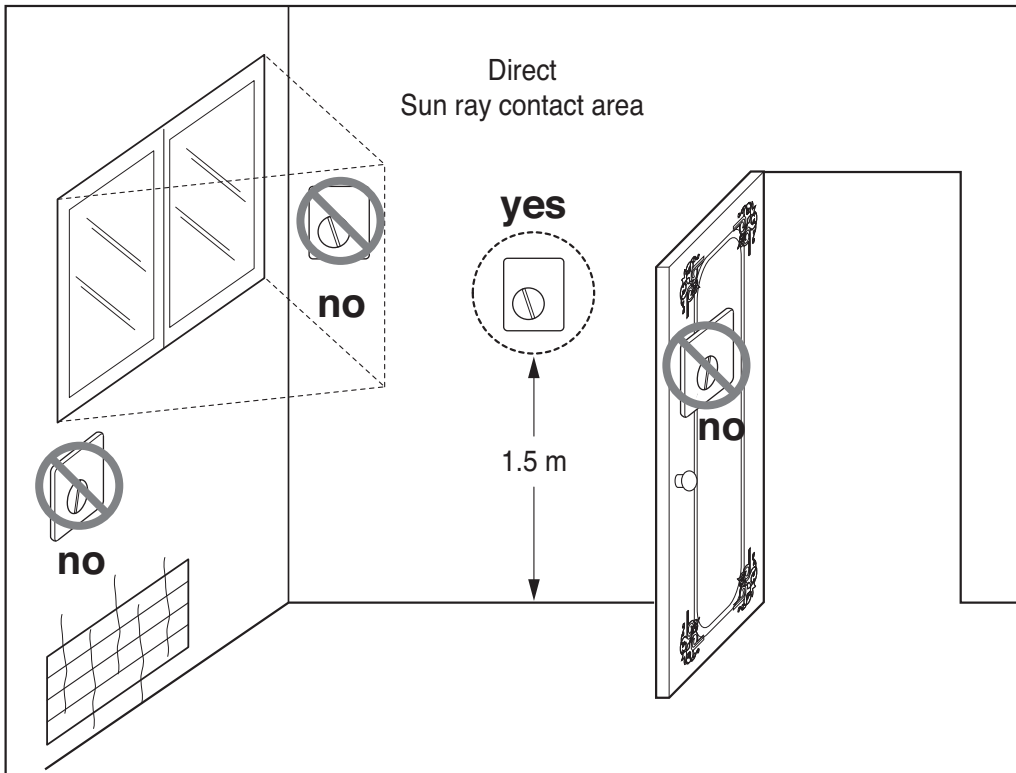

12. Accessories Installation

12.5.2 General Information

Hydro Kit supports following thermostats.

Type	Power	Operating Mode	Supported
Mechanical (1)	1~ 230 V	Heating Only (3)	Yes
Electrical (2)	1~ 230 V	Heating Only (3)	Yes

- (1) There is no electric circuit inside the thermostat and electric power supply to the thermostat is not required.
 (2) Electric circuit such as display, LED, buzzer, etc is included in the thermostat and electric power supply is required.
 (3) Thermostat generates "Heating ON or Heating OFF" signal according to user's heating target temperature.

12.5.3 How to Wire Thermostat

Follow below procedures Step 1 ~ Step 4.

- Step 1.** Uncover front cover of the unit and open the control box.
Step 2. Identify the power specification of the thermostat.
 1~230V thermostat is used in the Hydro Kit (For High Temperature).
Step 3. If it is Heating Only Thermostat, go to step 4.
Step 4. Find terminal block and connect wire as below.

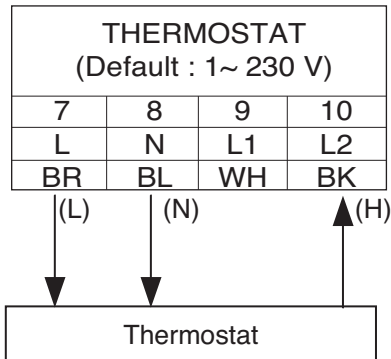

- (L) : Live signal from PCB to Thermostat
 (N) : Neutral signal from PCB to Thermostat
 (H) : Heating signal from Thermostat to PCB

12. Accessories Installation

12.5.4 Final Check

- DIP switch setting :
Set DIP switch No. 8 to 'ON'. Otherwise, the unit can not recognize the thermostat.
- Remote Controller :
 - 'Thermostat' icon is displayed on the remote controller.
 - Button input is prohibited.

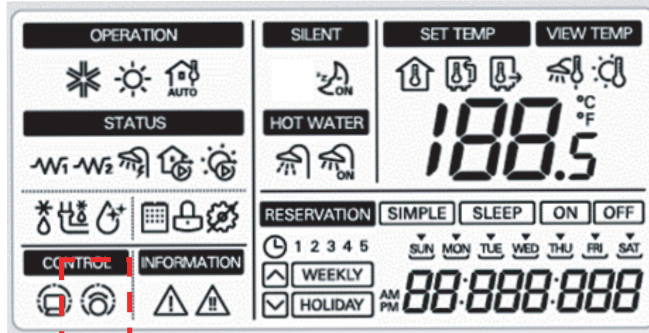





Thermostat Icon

NOTICE



Thermostat Operation with Remote Controller

Following features are permitted when thermostat is installed :

-  SET TEMP button
-  VIEW TEMP button
-  Temperature adjusting button (*)
-  Sanitary water heating button

(*) : The unit is not turned on/off according to the setting temperature at the remote controller.
It is turned on/off according to the thermostat signal.

Following features are NOT permitted when thermostat is installed :

-  Operating mode (heating/ weather-dependent) selection
-  Time scheduling
-  Operation On / Off

12.5.5 Sequence of thermostat operation

- How to set the heating temperature when thermostat is connected to the **Hydro Kit**.



12. Accessories Installation

12.6 Remote Temperature Sensor

Remote temperature sensor can be installed any place a user wants to detect the temperature.

How to Install Remote Temperature Sensor

- Step 1.** After deciding where the remote temperature sensor is installed, decide the location and height of the fixing screws. (Interval between the screws : 60mm)
- Step 2.** Insert the connector of the connection wire into the space for the connector in place of the room temperature sensor.(CN_ROOM)
- Step 3.** Separately, set the option code of the attached controller on the indoor unit.
In detail, refer to "installer setting mode".
- Step 4.** The Connection wire does not matter if you change the color of the wire because of non-polar.

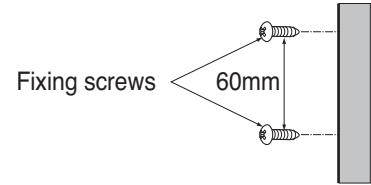

- Step 5.** Integrate the remote temperature sensor with the screws as the order of arrows.

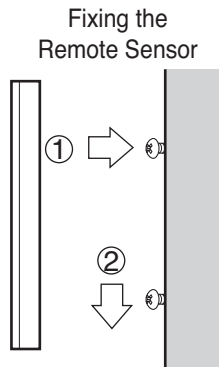

CAUTION

1. Choose the place where the average temperature can be measured for the indoor unit operates.
2. Avoid direct sunlight.
3. Choose the place where the heating devices do not affect the remote sensor.
4. Choose the place where the outlet of the cooling fan do not affect the remote sensor.
5. Choose the place where the remote sensor isn't affected when door is open.

12. Accessories Installation

12.7 3Way Valve

3way valve is required to operate sanitary water tank. Role of 3way valve is flow switching between under floor heating loop and water tank heating loop.

12.7.1 General Information

Hydro Kit supports following 3way valve.

Type	Power	Operating Mode	Supported
SPDT 3-wire (1)	1~ 230 V	Selecting "Flow A" between "Flow A" and "Flow B" (2)	Yes
		Selecting "Flow B" between "Flow A" and "Flow B" (3)	Yes

(1) SPDT = Single Pole Double Throw. Three wires consist of Live (for selecting Flow A), Live 1 (for selecting Flow B), and Neutral (for common).

(2) Flow A means 'water flow from the unit to sanitary water tank'

(3) Flow B means 'water flow from the unit to under floor water circuit'

12.7.2 How to Wire 3Way Valve

Follow below procedures Step 1 ~ Step 2.

Step 1. Uncover front cover of the unit and open the control box.

Step 2. Find terminal block and connect wire as below.

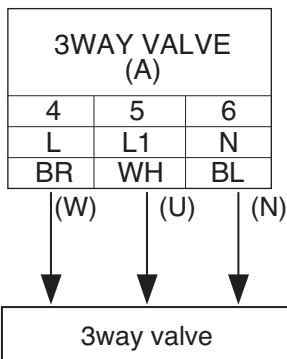

WARNING :

- 3way valve should select water tank loop when electric power is supplied to wire (W) and wire (N).
- 3way valve should select under floor loop when electric power is supplied to wire (U) and wire (N).

(W) : Live signal (Water tank heating) from PCB to 3way valve

(U) : Live signal (Under floor heating) from PCB to 3way valve

(N) : Neutral signal from PCB to 3way valve

WARNING :

Mice can not be appeared to prevent entering the unit or attacking wires.

12.7.3 Final Check

- Flow direction :
 - Water should flow from water outlet of the unit to sanitary tank water inlet when sanitary tank heating is selected.
 - To verify the flow direction, check temperature at the water outlet of the unit and water inlet of sanitary water tank.
 - If correctly wired, these temperatures should be almost equivalent if thermal insulation of water pipe is well performed.
- Noise or water pipe vibration while 3way valve operation
 - Due to surging effect or cavitation effect, noise or water pipe vibration can be occurred while 3way valve is operating.
 - In that case, check followings :
 - Is water circuit (both under floor water loop and sanitary water tank loop) fully charged? If not, additional water charging is required.
 - Fast valve operation yields noise and vibration. Appropriated valve operating time is 60~90 seconds.

12. Accessories Installation

12.8 Dry Contact

LG Dry Contact is a solution for automatic control of HVAC system at the owner's best. In simple words, it's a switch which can be used to turn the unit On/Off after getting the signal from external sources like key-in lock, door or window switch etc specially used in Hotel rooms.

How to Install Dry Contact

Connect CN_DRY with Control Unit.

- To apply power source through Dry Contact PCB.

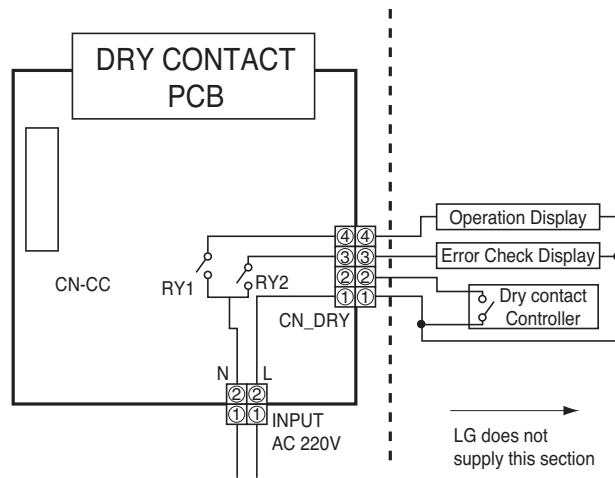

- To apply power source directly to external source.

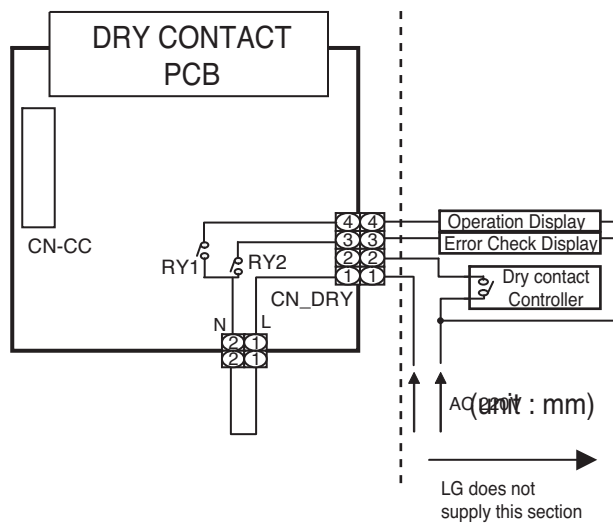

13. System Set-Up

As **Hydro Kit** (For High Temperature) is designed to satisfy various installation environment, it is important to set up system correctly. If not configured correctly, improper operation or degrade of performance can be expected.

13.1 DIP Switch Setting

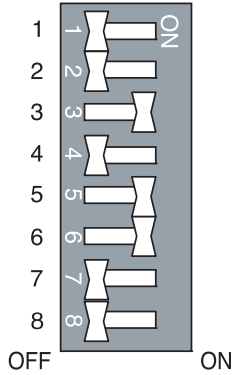

- Turn off electric power supply before setting DIP switch, There is risk of electric shock.
- Dip switch is turned on when pulled right.
- Always set dip switch #6 to ON and #7 to OFF.
- Do not set dip switch #2 to ON and #3 to OFF.
- If dip switch is not set as below, the unit may not operate properly.

x : OFF ● : On

Description	Dip switch setting								Function	Default
	1	2	3	4	5	6	7	8		
Group Control	x								Master	○
	●								Slave	
Installation Scene		x	x						Floor heating only	
		x	●						Floor heating + Hot water	○
		●	●						Hot water only	
Emergency operation				x					High temperature operation	○
				●					Low temperature operation	
Water pump control					x				Water pump controlled with Hydro Kit	
					●				Water pump NOT controlled with Hydro Kit	○
Thermostat connection								x	Thermostat NOT installed	○
								●	Thermostat installed	

13. System Set-Up

13.2 Group Control Setting

Group Control

- Wired remote controller 1 + Many of **Hydro Kit**

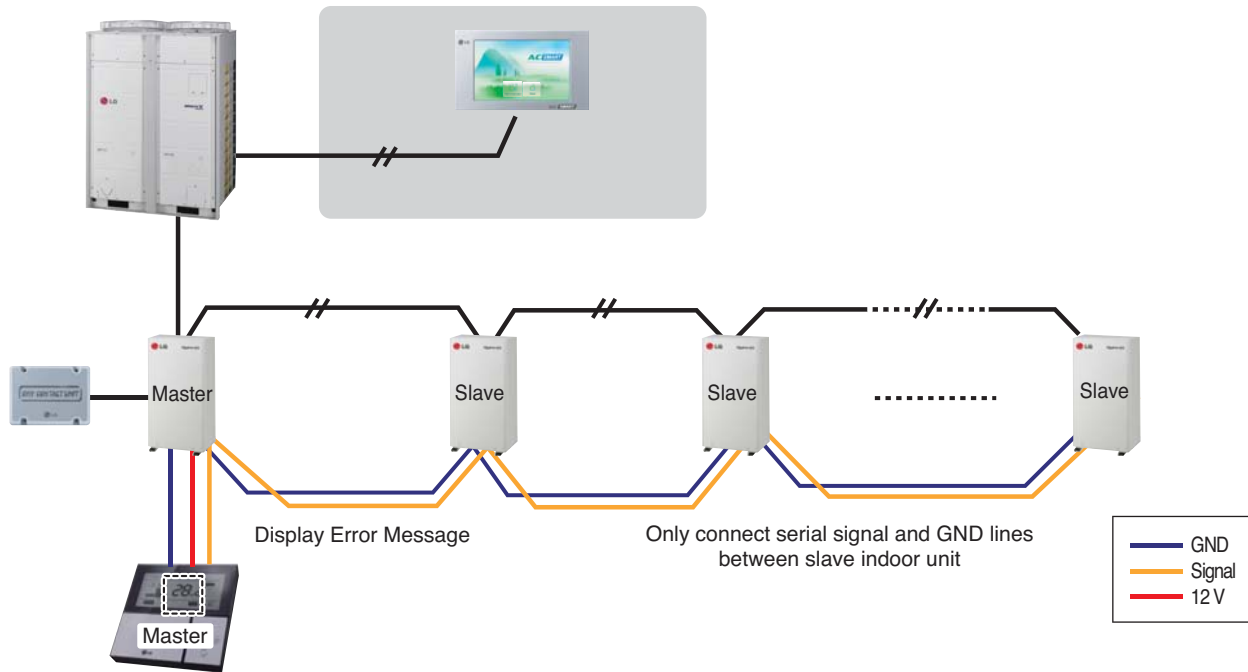

Hydro Kit (High Temp.)

- Dip Switch in PCB

① **Master Setting**
- No. 1 Off

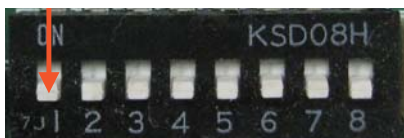

② **Slave Setting**
- No. 1 On



1. It is possible to connect 16 indoor units(Max) by one wired remote controller.

Set only one indoor unit to Master, set the others to Slave.

2. You can connect all the types of 2nd generation indoor units .

3. It is possible to use wireless remote controller at the same time.

4. It is possible to connect Dry Contact and Central controller at the same time.

- The Master indoor unit is possible to recognize Dry Contact and Central Controller only.
- In case of Central controller and Group controller at the same time, it is possible to connect standard 2series indoor units or later since Feb. 2009.
- In case of Central controller setting, the Central controller can control indoor units after setting only the address of master indoor unit.
- Slave indoor unit will be operated like master indoor unit.
- Slave indoor unit can not be individually controlled by Central controller.
- Some remote controller can't perform with Dry Contact and Central controller at the same time. So contact us further information about it.

13. System Set-Up

5. In case that the indoor unit has an abnormal problem an error code will be displayed on the wired remote controller.
With the exception of the indoor unit with the error, you can control each indoor unit individually.
 6. In case of Group Control, it is possible to use following functions.
 - Selection of operation options (operation/stop/mode/set temperature)
 - Control of flow rate (High/Middle/Low)
 - It is not possible at some functions.
- ※ Master/Slave setting of indoor units be set possible using a PCB Dip Switch.
- ※ It is possible to connect indoor units since Feb. 2009.
In the other cases, please contact LGE.
- ※ It can be the cause of malfunctions when there is no setting of master and slave.

Accessories for group control setting

- Accessories for group control setting

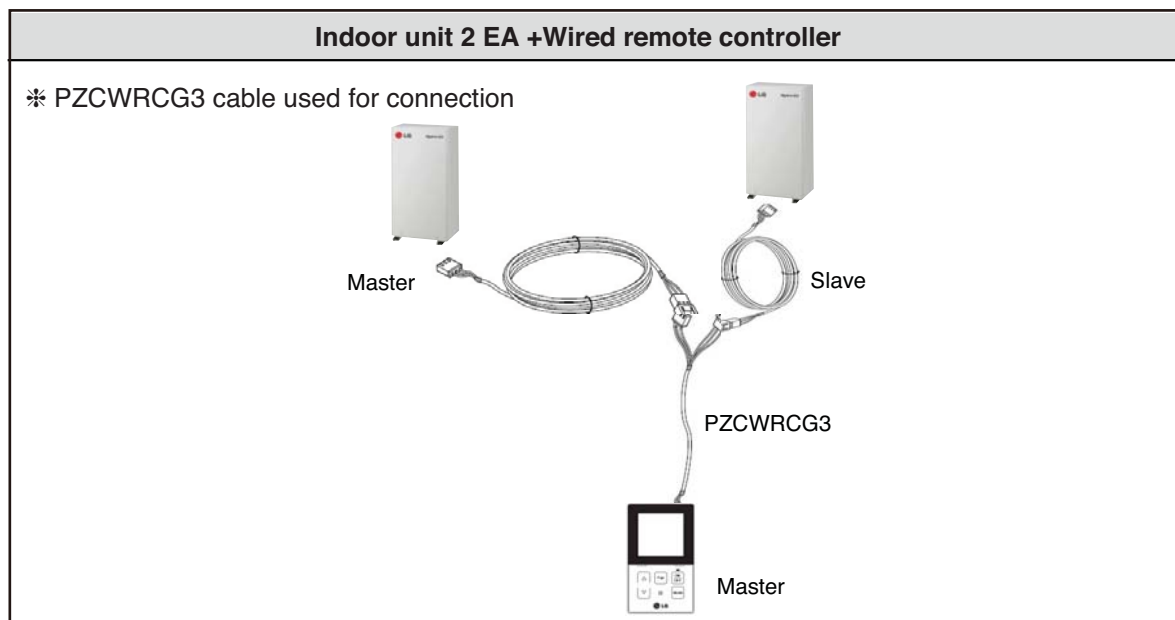

13. System Set-Up

NOTICE

Emergency Operation

• Definition of terms

- **Trouble** : a problem which can stop system operation, and can be resumed temporally under limited operation without certificated professional's assist.
- **Error** : problem which can stop system operation, and can be resumed ONLY after certificated professional's check.
- **Emergency mode** : temporary heating operation while system met Trouble.

• Objective of introducing 'Trouble'

- Not like airconditioning unit, **Hydro Kit** is generally operated in whole winter season without any system stopping.
- If system found some problem, which is not critical to system operating for yielding heating energy, the system can temporarily continue in emergency mode operation with end user's decision.

• Classified Trouble

- Trouble is classified two levels according to the seriousness of the problem : Slight Trouble and Heavy trouble
- **Slight Trouble** : Sensor trouble.
- **Heavy trouble** : Compressor cycle trouble.
- **Option Trouble** : a problem is found for option operation such as water tank heating. In this trouble, the troubled option is assumed as if it is not installed at the system.





• Emergency operation level

- When the system is faced with trouble, it stops and waits for user's decision. : Calling service center or starting emergency operation.
- To start emergency operation, user simply push ON / OFF button once more.
- Two different levels are prepared for emergency operation : High temperature cycle and low temperature cycle.
- In emergency operation mode, user can not adjust target temperature.

	DIP Switch (No. 4)	Target Leaving Water Temperature	Target Room Air Temperature	Target Sanitary Water Temperature
High temperature cycle	OFF	70°C(158°F)	24°C(75°F)	70°C(158°F)
Low temperature cycle	ON	50°C(122°F)	19°C(66°F)	50°C(122°F)

13. System Set-Up

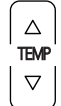

• **Following features are permitted in emergency operation :**

-  Operation On/Off
-  VIEW TEMP button(*)
-  Temperature adjusting button (**)
-  Sanitary water heating button

(*) : Temperature measured by failed sensor is displayed as '- -'.

(**) : The unit is not turned on/off according to the setting temperature at the remote controller.
It is turned on/off according to the thermostat signal.

• **Following features are NOT permitted in emergency operation :**

-  Operating mode (heating/ weather-dependent) selection
-  Time scheduling
-  SET TEMP button

• **Duplicated trouble : Option trouble with Slight or Heavy trouble**

If option trouble is occurred with slight (or heavy) trouble at the same time, the system puts higher priority to slight (or heavy) trouble and operates as if slight (or heavy) trouble is occurred.

Therefore, sometimes sanitary water heating can be impossible in emergency operation mode. When sanitary water is not warming up while emergency operation, please check whether the sanitary water sensor and related wiring are connected well or not.

• **Emergency operation is not automatically restarted after main electricity power is reset.**

In normal condition, the unit operating information is restored and automatically restarted after main electricity power is reset.

But in emergency operation, automatic re-start is prohibited to protect the unit.

Therefore, user must restart the unit after power reset when emergency operation has been running.

13. System Set-Up

13.3 Installer Setting

How to enter installer setting mode

CAUTION

Installer setting mode is to set the detail function of the remote controller.
If the installer setting mode is not set correctly, it could cause problems to the unit, user injury or property damage. This must be set by an certificated installer, and any installation or change that is carried out by a non-certificated person should be responsible for the results. In this case, free service cannot be provided.

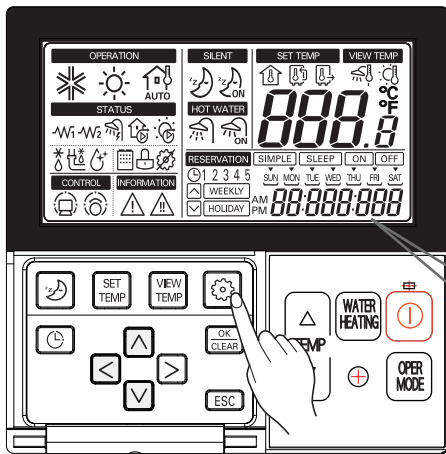

1 Press Function Setting button for 3 seconds to enter the installer setting mode.



Function Code Value

(When you enter the installer setting mode initially, function code is displayed on the bottom of the LCD screen.)

Repeat pressing button, and the function code will be changed from 01 to 2B.
Please refer the code table on the next page.

13. System Set-Up

Summary

Example of Fuction Code Display

02:00 : 155

Function Code Value #1 Value #2

Function	Default	Value #1	Value #2	Remark
Disable 3 Min. Delay	02:01	01	-	
Remote Air Sensor Connection	03:01	01 : NOT connected. 02 : connected.	-	
Celsius/Fahrenheit Switching	04:01	01 : Celsius 02 : Fahrenheit	-	
Setting Temp. Selection	05:02	01 : Air Temp. 02 : Leaving water Temp.	-	
Auto Dry Contact	06:01	01 : Auto Start OFF 02 : Auto Start ON	-	
Address Setting	07:00	00 ~ FF	-	
Override Setting	08:00	00 : Slave 01 : Master	-	
Water Pump Test Run	09:00	01 : Set		
Setting Air Temp. (Heating Mode)	13:030:016	24°C(75°F) ~ 30°C(86°F) : Upper Limit of setting range	16°C(60°F) ~ 22°C(71°F) : Lower Limit of setting range	
Setting Leaving Waer Temp. (Heating Mode)	14:080:046	50°C(122°F) ~ 80°C(176°F) : Upper Limit of setting range	30°C(86°F) ~ 46°C(114°F) : Lower Limit of setting range	
Setting Sanitary Tank Water Temp. (Sanitary Water Heating)	15:080:046	50°C(122°F) ~ 80°C(176°F) : Upper Limit of setting range	30°C(86°F) ~ 46°C(114°F) : Lower Limit of setting range	
Setting outdoor Temp. range (Weather-dependent operation)	23:-10:015	10°C(50°F) ~ 20°C(68°F) : Upper Limit of setting range	-20°C(-4°F) ~ 05°C(41°F) : Lower Limit of setting range	
Setting indoor air Temp. range (Weather-dependent operation)	24:021:016	20°C(68°F) ~ 30°C(86°F) : Upper Limit of setting range	16°C(60°F) ~ 19°C(66°F) : Lower Limit of setting range	
Setting leaving water Temp. (Weather-dependent operation)	25:080:046	65°C(149°F) ~ 80°C(176°F) : Upper Limit of setting range	40°C(104°F) ~ 54°C(129°F) : Lower Limit of setting range	
Setting start/maintain time (Disinfection Operation)	26:000	00 : Disable 01 : Enable	-	
	26:006:023	01~07 : Starting Date (01:Sun, 02:Mon, ..., 07:Sat)	00~23 hours : Starting Time in 24 hours	
Setting Temp. (Disinfection Operation)	27:070:010	40°C(104°F) ~ 70°C(129°F)70 : Maximum heating Temp.	05~60 min : Maximum heating duration	
Setting control parameter (Sanitary water heating operation)	28:005:080	01°C(33°F) ~ 20°C(68°F) : Temp. gap from Value #2	50°C(122°F) ~ 80°C(176°F)	
Setting control parameter (Sanitary water heating operation)	29:003:000	02°C(35°F) ~ 04°C(39°F)	00~01	
Sanitary water heating timers	2b:030	5 ~ 95 min (step: 5 min)	-	
	2b:180:020	0 ~ 600 min (step: 30 min)	20 ~ 95 min (step: 5 min)	
Change thermal on/off Air Temp.	2E:00	00~03	-	
Change thermal on/off Leaving Water Temp.	2F:00	00~03	-	
Program version	30:***	Display Version number	-	

*Temp. = Temperature

Common Setting

- **Function Code 02** : Disable 3 minute Delay
Only used for an inspection in a factory.

- **Function Code 03** : Remote Air Sensor Connection
If remote air sensor is connected to control the unit by room air temperature, the connection information should be notified to the unit.
Note : If remote air sensor is connected but this function code is not set correctly, the unit can not be controlled by room air temperature.

- **Function Code 04** : Celsius/Fahrenheit Switching
Temperature is displayed in Celsius or Fahrenheit.

- **Function Code 05** : Setting Temperature Selection
The unit can be operated according to air temperature or leaving water temperature. The selection for setting temperature as air temperature or leaving water temperature is determined.
Note : Air temperature as setting temperature is ONLY available when Remote Air Sensor Connection is enabled and Function Code 03 is set as 02.

- **Function Code 06** : Auto Dry Contact
This function enables the Dry Contact to operate under Auto Run mode or Manual mode with remote controller.
If thermostat is used, value should be changed from "2" to "1".

- **Function Code 07** : Address Setting
When Central Controller is installed, address assigning is set by this function.

- **Function Code 08** : Override Setting
Override master/slave selection function is to prevent the unit's different mode operation. If the unit is set as the slave, it blocks a change of opposite operating mode(cooling/heating).
* To use override master/slave selection function is only possible when units are connected in series to the outdoor unit.

- **Function Code 09** : Water Pump Test Run
After water pipe work is done, Water Pump Test Run mode should be performed to check whether water circulation is normal.



13. System Set-Up

Temperature Range Setting

- **Function Code 13** : Setting Air Temperature in Heating Mode
Determine heating setting temperature range when air temperature is selected as setting temperature.



CAUTION

Only available when remote air temperature sensor is connected.

- Accessory PQRSTA0 should be installed.
- Also, Function Code 03 should be set properly.

- **Function Code 14** : Setting Leaving Water Temperature in Heating Mode
Determine heating setting temperature range when leaving water temperature is selected as setting temperature.

- **Function Code 15** : Setting Sanitary Tank Leaving Water Temperature
Determine heating setting temperature range of water tank leaving water.

NOTICE

Only available when sanitary water tank temperature sensor is installed.

- Sanitary water tank and sanitary water tank kit should be installed.
- DIP switch No. 2 and 3 should be set properly.

Temperature Control Parameter Setting and Etc

- **Function Code 23, 24, and 25** : Setting Weather-dependent operation
Weather-dependent operation is that the unit automatically adjusts target temperature (leaving water or room air) according to the outdoor air temperature.

- Value #1 and Value #2 of Function Code 23 : range of outdoor air temperature
- Value #1 and Value #2 of Function Code 24 : range of auto-adjustable target room air temperature
- Value #1 and Value #2 of Function Code 25 : range of auto-adjustable target leaving water temperature

Note : Weather-dependent operation is applied for heating mode only.

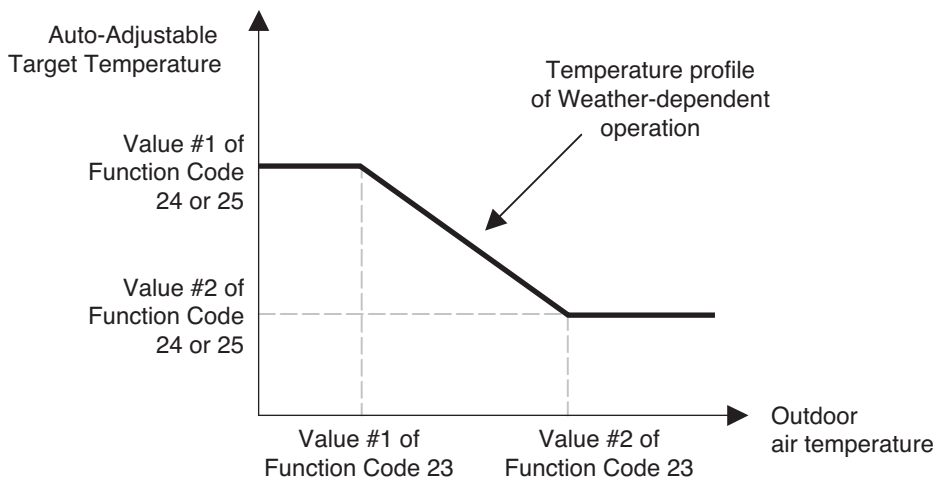

13. System Set-Up

• **Function Code 26 and 27** : Setting Disinfection operation

Disinfection operation is special sanitary tank operation mode to kill and to prevent growth of viruses inside the tank.

- Value #1 of Function Code 26 : Selecting disinfection operation mode. '00' for setting disinfection mode off, and '01' for setting disinfection mode on.
- Value #2 of Function Code 26 : Determining the date when the disinfection mode is running. '01' for Sunday, '02' for Monday, ... , and '06' for Saturday.
- Value #3 of Function Code 26 : Determining the time when the disinfection mode is running. '00' for 0:00am, '01' for 01:00am, ... , '22' for 10:00pm, and '23' for 11:00pm.
- Value #1 of Function Code 27 : Target temperature of disinfection mode.
- Value #2 of Function Code 27 : Duration of disinfection mode.

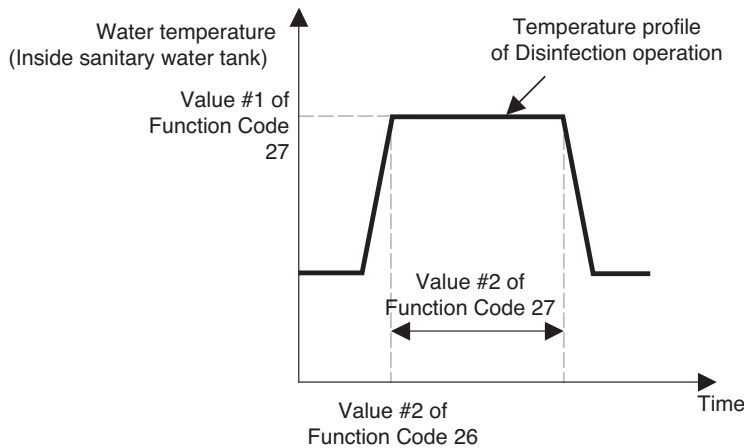

WARNING

Vales of Function Code 26

- If Value #1 of Function Code 26 is set as '00', Value #2 and Value #3 is not used.
- When Value #1 is set as '01', Value #2 is displayed at the position of Value #1 and Value #3 is displayed at the position of Value #2 due to limited width of the control panel display.

CAUTION

Sanitary water heating should be enabled

- If sanitary water heating is disabled, the disinfection mode will not be operated although Value #1 of Code 26 is set as '01'.
- To use disinfection mode, sanitary water heating should be enabled.

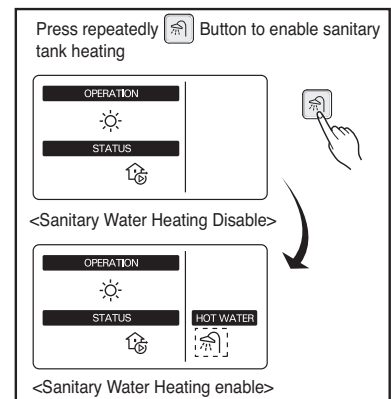

13. System Set-Up

- **Function Code 28 and 29** : Setting control parameter for Sanitary water heating operation

Descriptions for each parameters are as following.

- Value #1 of Function Code 28 : temperature gap from Value #2 of Function Code 28.
- Value #2 of Function Code 28 : maximum temperature.
- Example : If Value #1 is set as '5' and Value #2 is set as '80', then water tank heating will be started when the water tank temperature is below 75°C(167°F).
- Value #1 of Function Code 29 : temperature gap from target sanitary water temperature.
- Value #2 of Function Code 29 : Determining heating demand priority between sanitary water tank heating and under floor heating.
- Example : If user's target temperature is set as '50' and Value #1 is set as '3', then water tank heating will be turned off when the water temperature is above 53°C(127°F). Water tank heating will be turned on when the water temperature is below 50°C(122°F).
- Example : If Value #2 is set as '0', that means heating priority is on sanitary water heating, In this case the under floor can not be heated while sanitary water heating. On the other hand, if the Value #2 is set as '1', that means heating priority is on under floor heating, sanitary tank can not be heated while under floor heating.

NOTICE

Sanitary water heating does not operate when it is disabled.

Enabling / Disabling sanitary water heating to operate is determined by pushing  button.

When  icon is displayed on the remote controller, sanitary water heating is enabled.
(by button input or scheduler programming)

13. System Set-Up

• **Function Code 2B** : Setting sanitary water heating timers

Determine time duration : Operation time and stop time of sanitary tank heating.

- Value #1 of Function Code 2B : This time duration defines how long sanitary tank heating can be continued.
- Value #2 of Function Code 2B : This time duration defines how long sanitary tank heating can be stopped. It is also regarded as time gap between sanitary tank heating cycle.
- Example of timing chart :

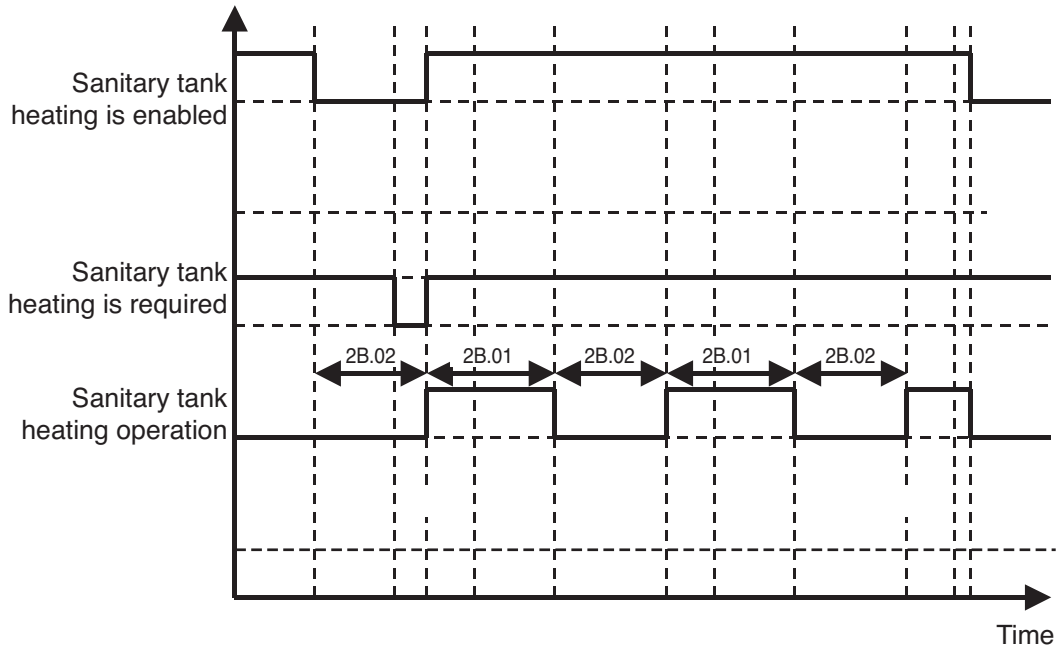

• **Function Code 2E and 2F** : Changing thermal on/off temperature

Select Thermal on/off Temperature gap.

2E : Room Air temperature

	Th On	Th Off
0	-0.5°C	1.5°C
1	4°C	6°C
2	2°C	4°C
3	-1°C	1°C

2F : Leaving Water temperature

	Th On	Th Off
0	-2°C	2°C
1	-6°C	4°C
2	-2°C	4°C
3	-1°C	1°C

• **Function Code 30** : Remote Controller Program Version

Display Remote Controller Program Version.

14. Test Run

14.1 Caution before Operation Test

- Check whether water flow is smoothly supplied.
- Check whether the flow switch properly operates.
- Check whether the connection status is good.
- Check whether the power cable and communication cable are completely connected.
- Check whether it is 2.0MΩ or above, when insulation resistance between the terminal block and ground is measured with DC mega tester (DC 500V).
- Never check insulation resistance for the connector of the control board.

14.2 Operation Test of Water Pipe

Category	Status	Checkpoint
Flow Switch Error	CH14	Check whether operation of water pipe is normal.
		Check for the block inside water pipe.
		(Strainer cleaning, valve locked, valve malfunction, air remaining, etc.)
		Check problem with flow switch.
		(Flow switch disorder, untold operation, disconnection, etc.)

14. Test Run

14.3 Troubleshooting

- This function displays the disorder types at the self diagnostics and the occurrence of the disorder for the product.
 - The disorder display shows the code in the following table on the red/green LED of the wired remote controller and outdoor unit control board.
 - If two or more types of disorders occur simultaneously, it displays in the order of the error number.
 - If inverter PCB error occurs, No. 12 error is displayed in the remote controller, and inverter PCB board LED can be used to verify detail error display.
 - After error occurs, the error code disappears when the disorder is repaired.
- * Error code 01, 08, 17, 18 can be operated with emergency operation.

Error No.	Error Type	Main Reasons
01	Air temperature sensor error	Air temperature sensor disconnection or short circuit
02	Gas side temperature sensor error	Gas side temperature sensor disconnection or short circuit
03	No communication between wired remote controller & indoor unit	The remote controller does not receive the signal from indoor unit during specific time
05	Indoor unit & outdoor unit communication error	No signal communication between indoor unit & outdoor unit
06	Liquid side temperature sensor error	Liquid side temperature sensor disconnection or short circuit
08	Water tank temperature sensor error	Water tank temperature sensor disconnection or short circuit
09	Indoor unit EEPROM error	Communication between the micro-processor & the EEPROM / Error due to EEPROM damage
11	Indoor unit & inverter PCB communication error	No signal communication between indoor unit & inverter PCB
12	Inverter PCB error	Error occurrence in inverter PCB
14	Flow switch error	Abnormal working of flow switch
15	Water pipe overheated	Water outlet temperature is above 90°C
16	Water inlet & outlet temperature sensor error	Water inlet & outlet temperature sensor disconnection or short circuit simultaneously
17	Water inlet temperature sensor error	Water inlet temperature sensor disconnection or short circuit
18	Water outlet temperature sensor error	Water outlet temperature sensor disconnection or short circuit

14. Test Run

Inverter PCB error display method

Red LED means error number 10 digits, and green LED means 1 digit, and if red and green blink at the same time, it means the unit of 100.

Ex) When red and green LED blink once at the same time, and red LED blinks once, and green LED blinks once: error number 115



Red LED: 10 digits
Green LED: 1 digit

Error No.	Error Type	Main Reasons
21	Inverter compressor IPM defect	Inverter compressor drive IPM defect / inverter compressor defect
22	Inverter compressor overcurrent	Increase of inverter compressor CT value
23	Inverter compressor DC Link low voltage	After inverter activation relay is ON, DC voltage recharge defect
25	High/low Inverter input voltage	Inverter input voltage exceeds the unit limit and lasts for 4 sec. (173V ~ 289V)
26	Inverter compressor activation failure	Inverter compressor error, causing initial activation failure
27	Inverter PSC/PFC Fault Error	Error by overcurrent at inverter input
28	Inverter DC Link high voltage error	Inverter DC voltage recharge, causing compressor OFF
29	Inverter compressor overcurrent	Inverter compressor activation failure or increase of CT value
32	Excessive rise of inverter compressor discharge temperature	Excessive rise of inverter compressor discharge temperature, causing compressor OFF
34	Excessive rise of high pressure of inverter compressor	Excessive rise of high pressure of inverter compressor, causing compressor OFF
35	Excessive drop of low pressure of inverter compressor	Excessive drop of low pressure of inverter compressor, causing compressor OFF
36	Low pressure ratio error of inverter compressor	High pressure/low pressure ratio of inverter compressor is maintained at below 1.8 for 3 min. or more
40	Inverter compressor CT sensor defect	Inverter compressor CT sensor defect
41	Inverter compressor discharge pipe temperature sensor defect	Inverter compressor discharge temperature sensor disconnection or short circuit
42	Low pressure sensor defect of inverter compressor	Low pressure sensor disconnection or short circuit of inverter compressor
43	High pressure sensor defect of inverter compressor	High pressure sensor disconnection or short circuit of inverter compressor
44	Inverter inside air temperature sensor defect	Inverter inside air temperature sensor disconnection or short circuit
46	Inverter compressor suction pipe temperature sensor defect	Inverter compressor suction temperature sensor disconnection or short circuit
53	Communication error(indoor unit outdoor unit main PCB)	Outdoor unit does not receive signal from indoor unit
60	Inverter PCB EEPROM error	Inverter PCB EEPROM error
62	Excessive rise of inverter heatsink temperature	Inverter PCB heat generation, causing the rise of heatsink temperature
65	Inverter heatsink temperature sensor defect	Inverter heatsink temperature sensor disconnection or short circuit
73	Overcurrent (Peak) detected at inverter input	Error by overcurrent detection at inverter input



P/No.: MFL61741612



Air Conditioner

20 Yeouido-dong, Yeongdeungpo-gu,
Yeouido P.O.Box 335 Seoul,
150-721, Korea.
<http://www.lgeaircon.com>

All rights reserved

Printed in Korea December/2012
The specifications, designs, and
information in this brochure are subject to
change without notice.

The air conditioners manufactured by LG have received ISO9001 certificate for
quality assurance and ISO14001 certificate for environmental management system.